

PowerPact B-Frame

Circuit Breakers and Automatic Switches

User Guide

DOCA0095EN
10/2018



www.schneider-electric.com

Schneider
Electric™

Legal Information

The Schneider Electric brand and any registered trademarks of Schneider Electric Industries SAS referred to in this guide are the sole property of Schneider Electric SA and its subsidiaries. They may not be used for any purpose without the owner's permission, given in writing. This guide and its content are protected, within the meaning of the French intellectual property code (Code de la propriété intellectuelle français, referred to hereafter as "the Code"), under the laws of copyright covering texts, drawings and models, as well as by trademark law. You agree not to reproduce, other than for your own personal, noncommercial use as defined in the Code, all or part of this guide on any medium whatsoever without Schneider Electric's permission, given in writing. You also agree not to establish any hypertext links to this guide or its content. Schneider Electric does not grant any right or license for the personal and noncommercial use of the guide or its content, except for a non-exclusive license to consult it on an "as is" basis, at your own risk. All other rights are reserved.

Electrical equipment should be installed, operated, serviced, and maintained only by qualified personnel. No responsibility is assumed by Schneider Electric for any consequences arising out of the use of this material.

As standards, specifications, and designs change from time to time, please ask for confirmation of the information given in this publication.

Schneider Electric, I-Line, Micrologic, PowerPact and Square D are trademarks and the property of Schneider Electric SE, its subsidiaries and affiliated companies. All other trademarks are the property of their respective owners.

Table of Contents

Safety Information.....	7
Related Documents	8
PowerPact B-Frame Overview	9
PowerPact B-Frame Features	9
Features	9
Isolation Characteristics	10
Unit-Mount Devices	11
Unit-Mount Circuit Breaker Description	11
QR Code	11
Unit Mount Circuit Breaker Accessories	12
Sealing Accessories.....	13
I-Line Devices	14
I-Line Circuit Breaker Description	14
QR Code	14
I-Line Circuit Breaker Accessories.....	15
Magnetic Protection for Automatic Switches	16
PowerPact B Frame Ratings.....	16
Thermal-Magnetic Protection for Circuit Breakers	17
Thermal Protection.....	17
AC Magnetic Trip Levels.....	17
DC Magnetic Trip Levels.....	17
Environmental Conditions	18
Temperature	18
Extreme Atmospheric Conditions	19
Vibration.....	19
Electromagnetic Disturbance	19
Altitude.....	19
Powerpact B-Frame Insulation Requirements and Accessories	20
Insulation Accessories	20
Overview of PowerPact B Insulation Accessories	20
PowerPact B Insulation Accessories.....	21
Clearance Requirements for Unit Mount PowerPact B Circuit Breakers	22
PowerPact B Equipment Installation Requirements	22
Minimum Distances for Side-by-Side PowerPact B Installation	23
PowerPact B Minimum UL Enclosure Volume	23
Minimum PowerPact B Clearance Without Insulation Accessories.....	24
Minimum PowerPact B Clearance with Interphase Barriers	24
Minimum Clearance for PowerPact B with Long Terminal Shields.....	25
Minimum Clearance for PowerPact B with Live Parts	25
Minimum Clearance Between PowerPact B Backplate and Uninsulated Power Connectors	26
Operating PowerPact B-Frame Devices	27
Operating a Circuit Breaker with a Toggle Handle.....	27

Description of a Circuit Breaker with a Toggle Handle27

Opening, Closing, Resetting and Testing a Circuit Breaker with
Toggle Handle29

Locking of a Circuit Breaker with a Toggle Handle.....32

Operating a Circuit Breaker with a Direct Rotary Handle33

Description of a Circuit Breaker with a Direct Rotary Handle33

Opening, Closing, Resetting and Testing a Circuit Breaker with a
Direct Rotary Handle34

Locking a Circuit Breaker with a Direct Rotary Handle.....37

Operating a Circuit Breaker with a Front Extended Rotary Handle40

Description of a Circuit Breaker with a Front Extended Rotary
Handle40

Opening, Closing, Resetting and Testing a Circuit Breaker with a
Front Extended Rotary Handle41

Locking a Circuit Breaker with a Front Extended Rotary Handle.....45

Operating a Circuit Breaker with a Side Rotary Handle48

Description of a Circuit Breaker with a Side Rotary Handle48

Opening, Closing, Resetting and Testing a Circuit Breaker with a
Side Rotary Handle49

Locking a Circuit Breaker with a Side Rotary Handle.....51

Operating a Circuit Breaker with a 9421 Rotary Handle53

Description of a Circuit Breaker with a 9421 Rotary Handle53

Opening, Closing, Resetting and Testing a Circuit Breaker with a
9421 Rotary Handle54

Locking a Circuit Breaker with a 9421 Rotary Handle57

Operating a Circuit Breaker with a 9422 Toggle Handle60

Description of a Circuit Breaker with a 9422 Toggle Handle60

Opening, Closing, Resetting, and Testing a Circuit Breaker with a
9422 Toggle Handle61

Locking a Circuit Breaker with a 9422 Toggle Handle65

PowerPact B-Frame Electrical Auxiliary Devices.....67

PowerPact B Electrical Auxiliary Devices.....67

Summary of Electrical Auxiliary Devices67

Slots for Electrical Auxiliary Devices67

PowerPact B Indication Contacts68

Characteristics of PowerPact B Indication Contacts68

Operation of PowerPact B Auxiliary Indication Contacts69

PowerPact B Control Auxiliaries.....70

PowerPact B-Frame Remote Electrical Trip70

**Commissioning and Maintaining the PowerPact B-Frame Circuit
Breaker.....71**

Commissioning the PowerPact B Circuit Breaker71

List of Checks and Inspections71

A: Insulation Tests and Dielectric Strength Tests.....72

B: Temperature Rise Tests.....72

C: Inspect Switchboard.....72

D: Check Compliance with the Diagram72

E: Inspect Mechanical Equipment72

F: Check Mechanical Operation73

G: Clean Equipment.....73



Maintaining the PowerPact B Circuit Breaker during Operation	74
Environmental and Operating Conditions	74
Regular Preventive Maintenance	75
Maintenance Operations Required	75
Responding to a Powerpact B Circuit Breaker Trip	76
Taking Precautions Before Responding to a Trip	76
Identifying the Cause of the Trip	76
Checking Equipment After a Trip	77
Resetting the Circuit Breaker	77
Troubleshooting the PowerPact B Circuit Breaker	78
Repetitive Tripping	78
Circuit Breaker Does Not Close.....	78
Wiring Diagrams.....	79
PowerPact B Circuit Breaker Wiring Diagrams	79
PowerPact B DC Systems	79
PowerPact B DC Wiring Diagrams	80
Grounded B-Phase Systems (Corner-Grounded Delta).....	81
PowerPact B Electrical Accessory Wiring Diagrams	82
Indication Contacts	82
Remote Operation (MN/MX Voltage Release)	82



RSPSupply - 1-888-532-2706 - <https://www.RSPSupply.com>
See the product details here

Safety Information

Hazard Categories and Special Symbols

Read these instructions carefully and look at the equipment to become familiar with the device before trying to install, operate, service, or maintain it. The following special messages may appear throughout this bulletin or on the equipment to warn of hazards or to call attention to information that clarifies or simplifies a procedure.



The addition of either symbol to a “Danger” or “Warning” safety label indicates that an electrical hazard exists which will result in personal injury if the instructions are not followed.



This is the safety alert symbol. It is used to alert you to personal injury hazards. Obey all safety messages that follow this symbol to avoid possible injury or death.

⚠ DANGER
DANGER indicates a hazardous situation which, if not avoided, will result in death or serious injury.

⚠ WARNING
WARNING indicates a hazardous situation which, if not avoided, could result in death or serious injury.

⚠ CAUTION
CAUTION indicates a hazardous situation which, if not avoided, could result in minor or moderate injury.

NOTICE
NOTICE is used to address practices not related to physical injury.

NOTE: Provides additional information to clarify or simplify a procedure.

Please Note

Electrical equipment should be installed, operated, serviced, and maintained only by qualified personnel. No responsibility is assumed by Schneider Electric for any consequences arising out of the use of this material.

A qualified person is one who has skills and knowledge related to the construction, installation, and operation of electrical equipment and has received safety training to recognize and avoid the hazards involved.

FCC Notice

This equipment has been tested and found to comply with the limits for a Class A digital device, pursuant to part 15 of the FCC Rules. These limits are designed to provide reasonable protection against harmful interference when the equipment is operated in a commercial environment. This equipment generates, uses, and can radiate radio frequency energy and, if not installed and used in accordance with the instruction manual, may cause harmful interference to radio communications. Operation of this equipment in a residential area is likely to cause harmful interference in which case the user will be required to correct the interference at his own expense. This Class A digital apparatus complies with Canadian ICES-003.

Related Documents

Title of Documentation	Reference Number
PowerPact B-Frame 3P/4P Circuit Breakers - Instruction Sheet	EAV91182
PowerPact B-Frame 2P Circuit Breakers - Instruction Sheet	EAV91186
PowerPact B-Frame 1P Circuit Breakers - Instruction Sheet	EAV91187
PowerPact B-Frame 3P I-Line Circuit Breakers - Instruction Sheet	EAV91189
PowerPact B-Frame 2P I-Line Circuit Breakers - Instruction Sheet	EAV91190
PowerPact B-Frame 1P I-Line Circuit Breakers - Instruction Sheet	EAV91191
MN/MX Voltage Releases - Instruction Sheet	EAV91202
OF/SD Indication Contacts - Instruction Sheet	EAV91204
Connection Accessories - Instruction Sheet	NHA56713
Insulation Accessories - Instruction Sheet	EAV91215
Locking Accessories - Instruction Sheet	NHA56710
Terminal Spreaders - Instruction Sheet	NHA65088
Torque Limiting Breakaway Unit - Instruction Sheet	NHA85013
Interphase Barriers - Instruction Sheet	NHA98087
Open Door Shaft Operator - Instruction Sheet	EAV78496
Direct Rotary Handle - Instruction Sheet	EAV91208
Extended Rotary Handle - Instruction Sheet	EAV91209
Side Rotary Handle - Instruction Sheet	EAV91211
PowerPact B-Frame Door-Mounted Operating Mechanism - Instruction Sheet	NVE47392
PowerPact B-Frame Cable Operating Mechanism - Instruction Sheet	NVE52880
PowerPact B-Frame Dual-Cable Operating Mechanism - Instruction Sheet	NVE52881
PowerPact B-Frame Variable Depth Operating Mechanism - Instruction Sheet	NVE52882

You can download these technical publications and other technical information from our website at

<https://www.schneider-electric.us/en/download/>

PowerPact B-Frame Overview

PowerPact B-Frame Features

Features

PowerPact B-frame devices have the following features:

- Circuit breakers and automatic switches rated from 15 to 125 A
- Available constructions: 1, 2, 3, and 4 poles
- Available mounting types: unit mount and I-line
- Standard compliance depending on the version:
 - UL 489, CSA 22.2 No 5, and NMX-J-266
 - UL 489, CSA 22.2 No 5, NMX-J-266, and IEC/EN60947-2
 - UL 489, CSA 22.2 No 5, NMX-J-266, and IEC/EN60947-2, CCC
- Breaking capacities: D, G, J, K
- Voltage up to 600Y/347 Vac compliant with UL 489
- Voltage up to 690 Vac compliant with IEC/EN60947-2 (type J only)
- Voltage up to 250 Vdc compliant with UL 489, CSA 22.2 No 5, and NMX-J-266
- Field-installable electrical accessories
- Optional terminations
- Optional operating mechanisms
- Optional voltage releases (not available on 1-pole)
- Optional auxiliary contacts (not available on 1-pole)
- Optional insulation accessories
- Optional locking accessories

Isolation Characteristics

Circuit breakers offer positive contact indication and are suitable for isolation in accordance with standards IEC/EN60947-1 and IEC/EN60947-2. The O (OFF) position of the actuator is sufficient to isolate the circuit breaker.

The following markings on the device identification label indicate that the devices are capable of isolation:

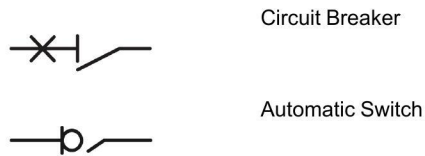

In accordance with installation rules, circuit breakers can be locked in the O (OFF) position so that work can be carried out with the power off. Circuit breakers can be locked in the O (OFF) position only when they are open.

NOTE: Locking a circuit breaker in the O (OFF) position is sufficient to isolate the circuit breaker.

The choice of locking device depends on the type of actuator:

- Locking circuit breakers with a toggle handle (see *Locking of a Circuit Breaker with a Toggle Handle, page 32*)
- Locking circuit breakers with a direct rotary handle (see *Locking a Circuit Breaker with a Direct Rotary Handle, page 37*)
- Locking circuit breakers with an extended rotary handle (see *Locking a Circuit Breaker with a Front Extended Rotary Handle, page 45*)
- Locking circuit breakers with a side rotary handle (see *Locking a Circuit Breaker with a Side Rotary Handle, page 51*)
- Locking circuit breakers with a 9421 rotary handle (see *Locking a Circuit Breaker with a 9421 Rotary Handle, page 57*)
- Locking circuit breakers with a 9422 toggle handle (see *Locking a Circuit Breaker with a 9422 Toggle Handle, page 65*)

Unit-Mount Devices

Unit-Mount Circuit Breaker Description

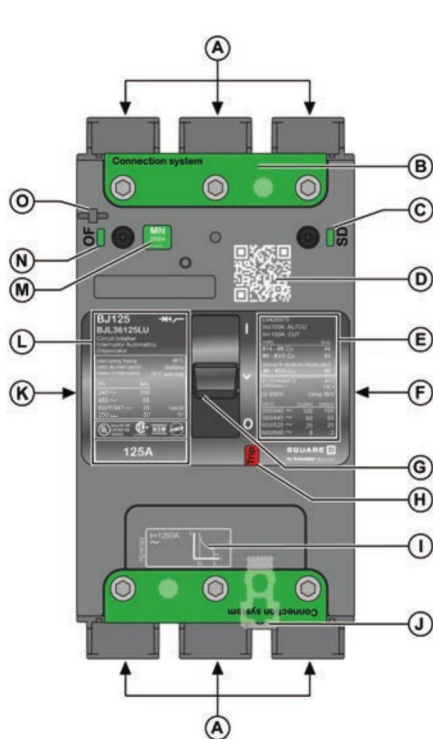

- A. Power connection (EverLink™ lug, EverLink lug with control wire terminal, compression lug / busbar, mechanical lug)
- B. Connection system cover
- C. SD presence indicator
- D. QR code to product information
- E. Termination information and IEC interrupting ratings
- F. Product and accessory data labels
- G. Toggle handle
- H. Push-to-trip button
- I. Protection/trip curve
- J. DIN rail lock
- K. Safety and information labels
- L. Device identification, certification marks, and UL interrupting ratings
- M. MN or MX presence indicator
- N. OF presence indicator
- O. Seal for accessory cover

QR Code

Scan the QR code to get additional information about the circuit breaker from the Schneider Electric web site. To scan the QR code, use a smartphone that is equipped with a camera and installed with a QR code reader.

Unit Mount Circuit Breaker Accessories

The following accessories are available for the unit mount circuit breaker.

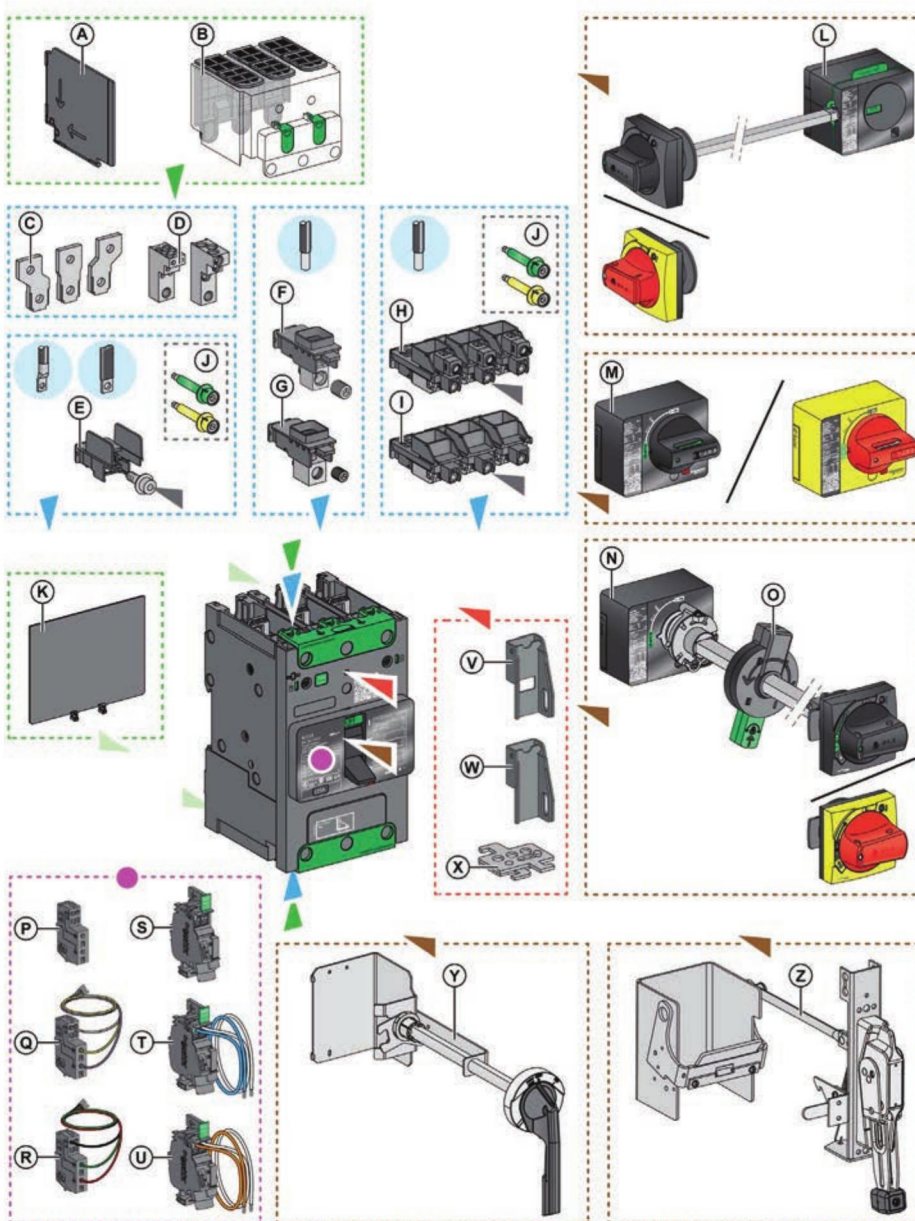

- A. Interphase barriers
- B. Long terminal shield
- C. Terminal spreaders
- D. Power distribution connectors (3-hole or 6-hole)
- E. Compression lug / busbar connector
- F. Copper mechanical lug
- G. Aluminum mechanical lug
- H. EverLink lug with control wire terminal
- I. EverLink lug without control wire terminal
- J. Torque limiting breakaway bits
- K. Rear insulating screen
- L. Side rotary handle (right or left)
- M. Direct mounted rotary handle
- N. Extended rotary handle
- O. Open door shaft operator
- P. Auxiliary contact (OF or SD)
- Q. Auxiliary contact (OF) pre-wired
- R. Auxiliary contact (SD) pre-wired
- S. Undervoltage Release (MN) or Shunt Trip (MX)
- T. Undervoltage release (MN) pre-wired
- U. Shunt trip ((MX) pre-wired
- V. Fixed toggle handle padlocking device (OFF and ON)
- W. Fixed toggle handle padlocking device (OFF only)
- X. Removable toggle handle padlocking device (OFF only)
- Y. Class 9421 extended rotary handle
- Z. Class 9422 toggle handle

Sealing Accessories

The following sealing accessories can help prevent unauthorized changes to the circuit breaker.

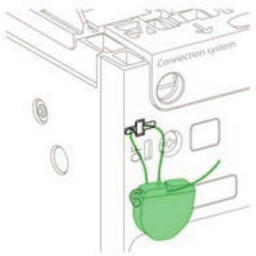
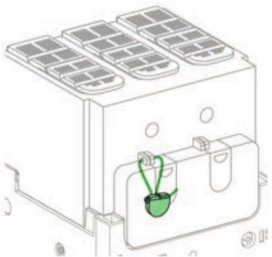
Seal Type	Helps to Prevent	Seal Image
Seal for cover	<ul style="list-style-type: none"> Removal of the front cover Access to the auxiliaries 	 <p>The diagram shows a side view of a circuit breaker. A green seal is shown being applied to the front cover. The seal is a cup-like shape with a stem that fits into a hole in the cover. The text 'Connection system' is visible on the top of the breaker.</p>
Seal for long terminal shield	<ul style="list-style-type: none"> Access to the power connections (helps to prevent direct contact) Dismounting of the circuit breaker 	 <p>The diagram shows a top-down view of a circuit breaker. A green seal is shown being applied to the long terminal shield. The seal is a cup-like shape with a stem that fits into a hole in the shield.</p>

I-Line Devices

I-Line Circuit Breaker Description

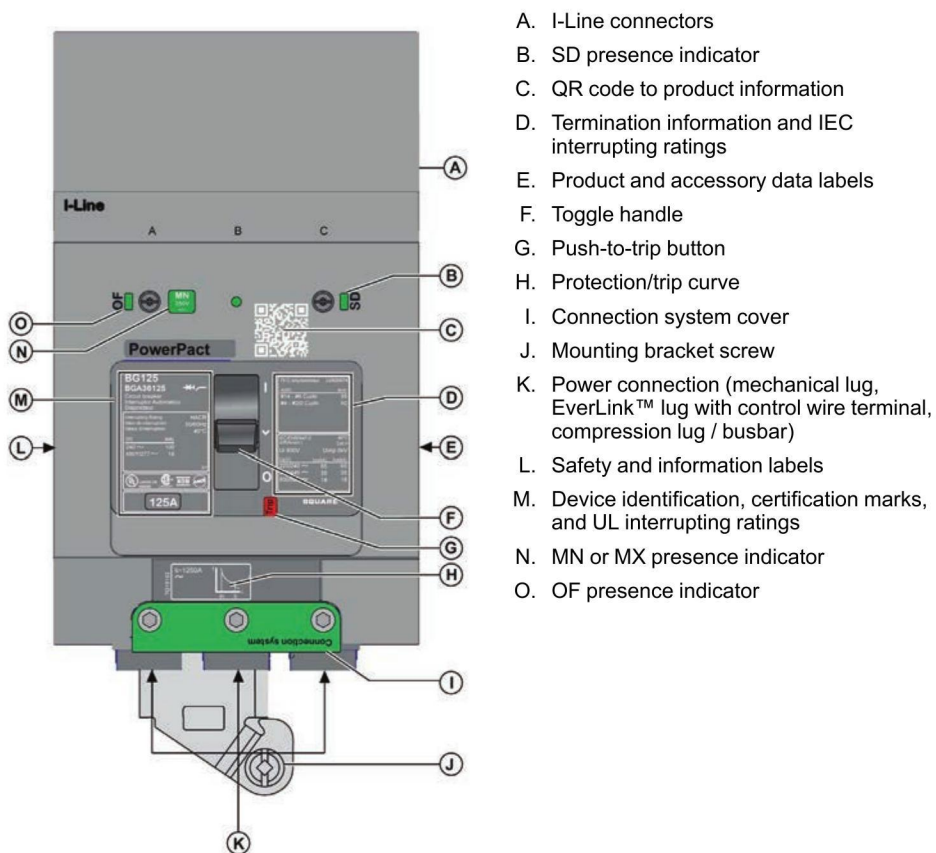

- A. I-Line connectors
- B. SD presence indicator
- C. QR code to product information
- D. Termination information and IEC interrupting ratings
- E. Product and accessory data labels
- F. Toggle handle
- G. Push-to-trip button
- H. Protection/trip curve
- I. Connection system cover
- J. Mounting bracket screw
- K. Power connection (mechanical lug, EverLink™ lug with control wire terminal, compression lug / busbar)
- L. Safety and information labels
- M. Device identification, certification marks, and UL interrupting ratings
- N. MN or MX presence indicator
- O. OF presence indicator

QR Code

Scan the QR code to get additional information about the circuit breaker from the Schneider Electric web site. To scan the QR code, use a smartphone that is equipped with a camera and installed with a QR code reader.

I-Line Circuit Breaker Accessories

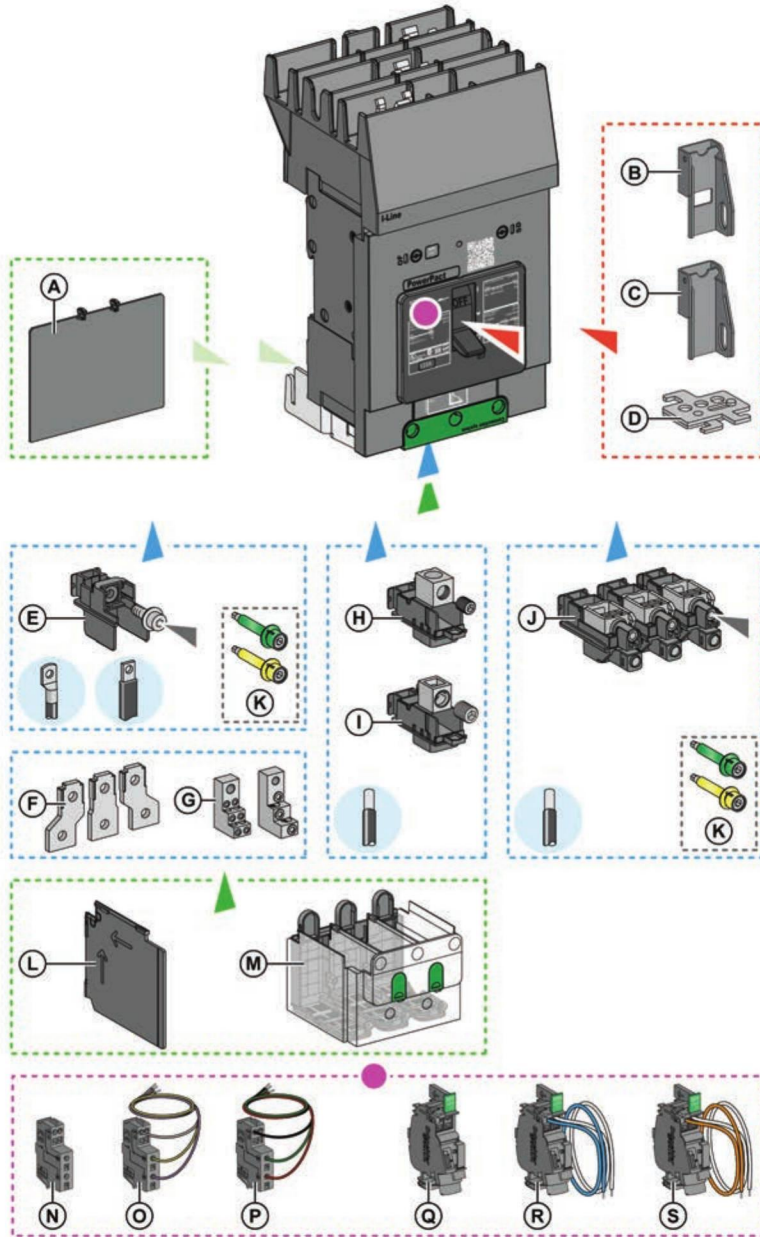

- A. Rear insulating screen
- B. Fixed toggle handle padlock device (OFF and ON)
- C. Fixed toggle handle padlock device (OFF only)
- D. Removable toggle handle padlocking device (OFF only)
- E. Compression lug / busbar connector
- F. Terminal spreaders
- G. Power distribution connectors
- H. Aluminum mechanical lug
- I. Copper mechanical lug
- J. EverLink lug with control wire terminal
- K. Torque limiting breakaway bits
- L. Interphase barriers
- M. Long terminal shield
- N. OF or SD auxiliary contact
- O. OF auxiliary contact pre-wired
- P. SD auxiliary contact pre-wired
- Q. MN or MX voltage release
- R. MN undervoltage release pre-wired
- S. S MX shunt trip pre-wired

Magnetic Protection for Automatic Switches

Automatic switches provide a fixed instantaneous trip point for general-purpose applications.

PowerPact B Frame Ratings

The following table summarizes the magnetic protection pick-up values for hold and trip events. The instantaneous trip point cannot be adjusted.

Event	Vac Pick-Up Values (Frame Rating In = 125 A)	Vdc Pick-Up Values (Frame Rating In = 125 A)
Hold	880 A	1060 A
Trip	1320 A	1640 A

Thermal-Magnetic Protection for Circuit Breakers

Thermal-magnetic protection provides the following features for general-purpose applications:

- Thermal protection against overload, with fixed threshold I_n .
- Instantaneous protection against short circuits, with fixed threshold I_i .

The following figure shows the trip curve.

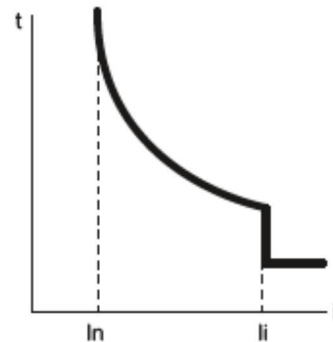

I_n Thermal protection pickup

I_i Instantaneous trip point

Thermal Protection

The thermal protection pick-up value cannot be adjusted. Its value for each frame rating is shown below.

	Frame rating I_n (A)														
	15	20	25	30	35	40	45	50	60	70	80	90	100	110	125
I_n pick-up (A)	15	20	25	30	35	40	45	50	60	70	80	90	100	110	125

AC Magnetic Trip Levels

I_i	Rated Current (A)														
	15	20	25	30	35	40	45	50	60	70	80	90	100	110	125
Hold (A)	400	400	400	400	400	400	400	480	640	640	800	1000	1000	1000	1000
Trip (A)	600	600	600	600	600	600	600	720	960	960	1200	1500	1500	1500	1500

DC Magnetic Trip Levels

The Time Current Curves (trip curves) provide the complete time-current characteristics of the circuit breaker when applied on an AC system. When applying thermal-magnetic circuit breakers on DC systems, they retain the same thermal tripping characteristics, but the magnetic trip levels vary. See table for the appropriate DC magnetic hold and trip levels.

I_i	Rated Current (A)														
	15	20	25	30	35	40	45	50	60	70	80	90	100	110	125
Hold (A)	460	460	510	510	510	510	510	510	790	900	900	1200	1200	1200	1200
Trip (A)	680	680	800	800	800	800	800	800	1240	1420	1420	1850	1850	1850	1850

Environmental Conditions

Temperature

The following temperatures are relevant for circuit breakers:

- Ambient temperature: the temperature of the air immediately surrounding the circuit breaker. If the temperature inside the enclosure is above 40 °C (104 °F), devices must be derated.
- Operating temperature range: -25 °C to +70 °C (-13 °F to +158 °F).
NOTE: Commissioning is possible down to -35 °C (-31 °F).
- Storage temperature range: -50 °C to +85 °C (-58 °F to +185 °F).

The following table gives the standard circuit breaker ampere ratings depending on the frame rating and the operating temperature in the enclosure.

Temperature		Frame Rating In (A)														
°C	°F	15 to 125														
40	104	15	20	25	30	35	40	45	50	60	70	80	90	100	110	125
45	113	14	19	24	29	34	39	44	49	58	67	77	87	99	107	121
50	122	14	19	24	28	33	38	42	47	56	64	73	83	96	103	117
55	131	13	18	23	27	32	37	41	45	55	61	70	80	92	99	112
60	140	12	18	22	26	31	36	39	44	53	59	67	76	85	94	109
65	149	12	17	21	25	31	35	37	42	51	55	63	72	80	89	104
70	158	11	16	20	24	30	33	36	40	48	53	59	68	69	76	100

The following table gives the correction factor that applies to tripping time depending on ambient temperature:

Temperature		Frame Rating In (A)														
°C	°F	15	20	25	30	35	40	45	50	60	70	80	90	100	110	125
10	50	1.21	1.16	1.15	1.16	1.13	1.14	1.17	1.16	1.16	1.18	1.19	1.19	1.21	1.19	1.17
15	59	1.18	1.13	1.13	1.14	1.14	1.14	1.14	1.14	1.14	1.14	1.14	1.14	1.14	1.14	1.14
20	68	1.15	1.11	1.11	1.11	1.09	1.10	1.12	1.11	1.11	1.13	1.12	1.12	1.15	1.13	1.12
25	77	1.11	1.08	1.08	1.08	1.07	1.07	1.09	1.08	1.08	1.10	1.0	1.10	1.12	1.10	1.09
30	86	1.08	1.06	1.05	1.06	1.05	1.05	1.06	1.06	1.06	1.06	1.06	1.06	1.09	1.07	1.06
35	95	1.04	1.03	1.03	1.03	1.02	1.03	1.03	1.03	1.03	1.03	1.03	1.04	1.05	1.04	1.03
40	104	1	1	1	1	1	1	1	1	1	1	1	1	1	1	1
45	113	0.96	0.97	0.97	0.97	0.98	0.97	0.97	0.97	0.97	0.96	0.96	0.99	0.99	0.98	0.96
50	122	0.92	0.94	0.94	0.94	0.95	0.95	0.94	0.94	0.94		0.92	0.92	0.96	0.94	0.94
55	131	0.87	0.91	0.91	0.91	0.93	0.92	0.90	0.91	0.91	0.88	0.88	0.89	0.92	0.90	0.90
60	140	0.83	0.88	0.88	0.87	0.90	0.89	0.87	0.87	0.88	0.84	0.83	0.84	0.85	0.85	0.87
65	149	0.78	0.85	0.85	0.84	0.87	0.86	0.83	0.84	0.84	0.79	0.79	0.80	0.80	0.80	0.83
70	158	0.72	0.81	0.82	0.80	0.85	0.83	0.79	0.80	0.81	0.75	0.74	0.75	0.69	0.70	0.80

Extreme Atmospheric Conditions

Circuit breakers are designed to operate in industrial atmospheres as defined in standard IEC/EN60947-2 for the highest level of pollution (level 3).

Circuit breakers are tested for extreme storage conditions and are compliant with the following standards:

Standard	Title
IEC60068-2-2	Dry heat, severity level +85 °C (+185 °F)
IEC60068-2-1	Dry cold, severity level –0 °C (–8 °F)
IEC60068-2-30	Damp heat: <ul style="list-style-type: none"> • Temperature +55 °C (+131 °F) • Relative humidity 95%
IEC60068-2-52	Salt mist, severity 2

Vibration

Circuit breakers are designed to withstand vibration. They meet the IEC60068-2-6 standard for vibration:

- 2 Hz to 25 Hz with an amplitude of +/- 1.6 mm (+/- 0.06 in.)
- 25 Hz to 100 Hz at a constant acceleration of +/- 4 g

Conformity tests are carried out in accordance with the IEC60068-2-6 standard, at the levels of severity required by the merchant shipping regulatory bodies (mainly IACS, Veritas, and Lloyd's).

Excessive vibration can cause tripping, breaks in connections, or damage to mechanical parts.

Electromagnetic Disturbance

Circuit breakers resist electromagnetic disturbance. They comply with the requirements of the electromagnetic compatibility (EMC) standard IEC60947-2.

Altitude

Circuit breakers are designed to operate within specification at altitudes up to 2,000 m (6,600 ft.). Above 2,000 m (6,600 ft), the following derating is required:

Characteristic		Altitude (m/ft)			
		2,000 m (6,600 ft)	3,000 m (9,800 ft)	4,000 m (13,000 ft)	5,000 m (16,500 ft)
Impulse withstand voltage	V _{imp}	8 kV	7.1 kV 6	6.4 kV	5.6 kV
Insulation voltage	V _i	800 V	710 V	635 V	560 V
Maximum operational voltage	V _e	690 V	690 V	635 V	560 V
Average current capacity (A) at 40 °C (104 °F)	I _{n x}	1	0.98	0.96	0.94

Powerpact B-Frame Insulation Requirements and Accessories

Insulation Accessories

Overview of PowerPact B Insulation Accessories

The following insulation accessories can be used with the range of PowerPact B-frame circuit breakers.

For more information, see the PowerPact B-Frame Catalog.

Insulation Accessory	EverLink Power Connectors				All Other Power Connectors			
	1P	2P	3P	4P	1P	2P	3P	4P
Long terminal shield	—	—	—	—	—	X	X	X
Interphase barriers	—	—	—	—	—	X	X	X
Rear insulation screen	—	X	X	X	—	X	X	X

PowerPact B Insulation Accessories

The following insulation accessories can be installed on-site.

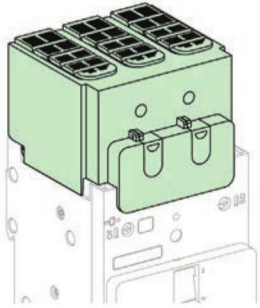
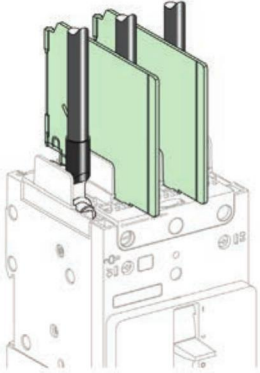
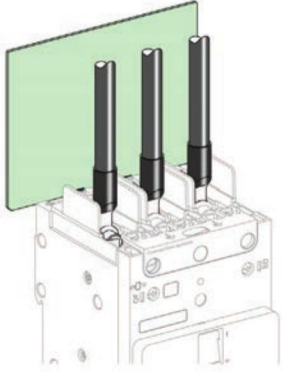
Insulation Accessory	Benefit	Accessory Image
Long terminal shield	IP40 protection	
Flexible interphase barriers	Improve insulation between power connections	
Rear insulation screen	Improve insulation between backplate and power connections, especially with spreaders	

Clearance Requirements for Unit Mount PowerPact B Circuit Breakers

When installing unit mount PowerPact B-frame circuit breakers and automatic switches in equipment, minimum distances (safety clearance) must be maintained between the device and panels, bars, or any metal installed nearby.

Minimum distances depend on the ultimate breaking capacity, and are defined by tests carried out in accordance with the IEC/EN60947-2 standard.

If IEC installation conformity is not checked by type tests, you must also:

- Use insulated bars for circuit breaker connections.
- Block off the busbars by using rear insulation screens.

PowerPact B Equipment Installation Requirements

DANGER

HAZARD OF ELECTRIC SHOCK, EXPLOSION, OR ARC FLASH

- Apply appropriate personal protective equipment (PPE) and follow safe electrical work practices. See NFPA 70E, CSA Z462, NOM-029-STPS, or local equivalent.
- This equipment must only be installed and serviced by qualified electrical personnel.
- Turn off all power supplying this equipment before working on or inside equipment.
- Turn off all power supplying the downstream equipment by manually opening the circuit breaker.
- Before working on or inside equipment, always use a properly rated voltage sensing device to confirm that power is off.
- Replace all devices, doors, and covers before turning on power to this equipment.
- Beware of potential hazards, and carefully inspect the work area for tools and objects that may have been left inside the equipment.

Failure to follow these instructions will result in death or serious injury.

Follow these guidelines when installing circuit breakers in equipment:

- Respect minimum distances.
- Perform dielectric strength tests, thermal calculations, and temperature rise tests as required by the configuration of the installation.
- Respect the limits defined in the derating tables, depending on the ambient temperature (ratings are based on IEC/EN60947-2 standard).

DANGER

HAZARD OF ELECTRIC SHOCK, EXPLOSION, OR ARC FLASH

Install circuit breaker so minimum clearance distance to grounded metal is maintained.

Failure to follow these instructions will result in death or serious injury.

Minimum Distances for Side-by-Side PowerPact B Installation

There is no minimum distance required between circuit breakers installed side-by-side.

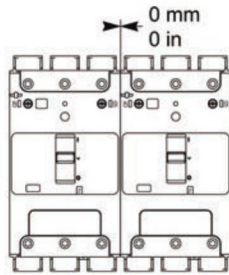

PowerPact B Minimum UL Enclosure Volume

The minimum enclosure dimensions (or equivalent calculated volume) required for the whole range of circuit breakers are shown below.

1P Front View

2P Front View

3P/4P Front View

Side View

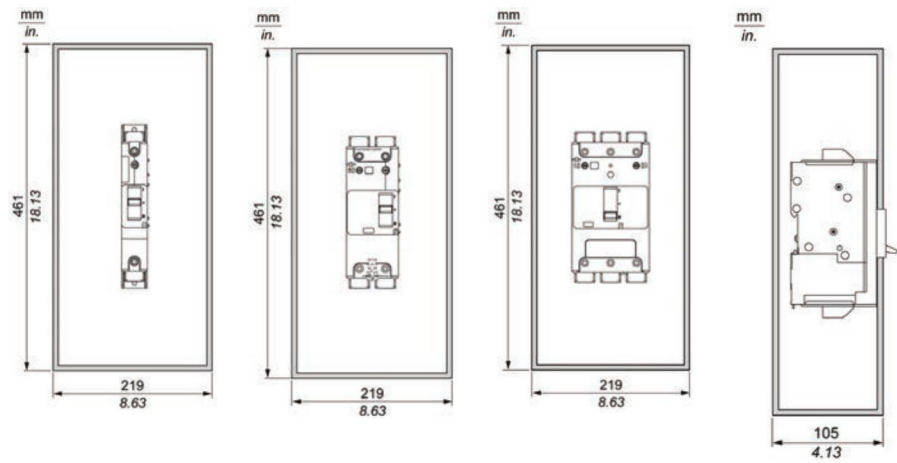

Minimum PowerPact B Clearance Without Insulation Accessories

The minimum clearance distances required around circuit breakers without insulation accessories are shown below.

1P

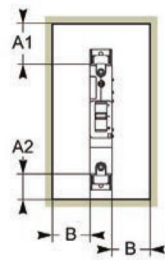

- With painted sheet metal:
- A1: 30 mm (1.18 in.)
 - A2: 5 mm (0.19 in.)
 - B: 0 mm (0 in.)
- With bare sheet metal:
- A1: 40 mm (1.57 in.)
 - A2: 5 mm (0.19 in.)
 - B: 5 mm (0.19 in.)

1P 2P

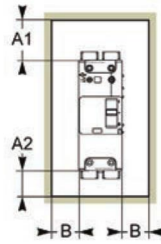

- With painted sheet metal:
- A1: 30 mm (1.18 in.)
 - A2: 5 mm (0.19 in.)
 - B: 0 mm (0 in.)
- With bare sheet metal:
- A1: 40 mm (1.57 in.)
 - A2: 5 mm (0.19 in.)
 - B: 5 mm (0.19 in.)

3P/4P

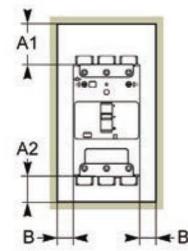

- With painted sheet metal:
- A1: 30 mm (1.18 in.)
 - A2: 5 mm (0.19 in.)
 - B: 0 mm (0 in.)
- With bare sheet metal:
- A1: 40 mm (1.57 in.)
 - A2: 5 mm (0.19 in.)
 - B: 5 mm (0.19 in.)

Minimum PowerPact B Clearance with Interphase Barriers

The minimum clearance distances required around circuit breakers equipped with interphase barriers are shown below.

2P

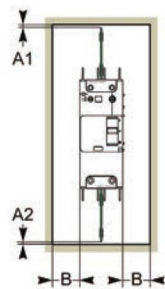

- With painted sheet metal:
- A1: 0 mm (0 in.)
 - A2: 0 mm (0 in.)
 - B: 0 mm (0 in.)
- With bare sheet metal:
- A1: 0 mm (0 in.)
 - A2: 0 mm (0 in.)
 - B: 5 mm (0.19 in.)

3P/4P

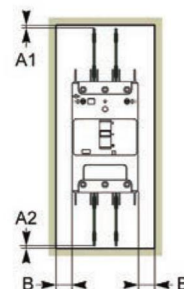

- With painted sheet metal:
- A1: 0 mm (0 in.)
 - A2: 0 mm (0 in.)
 - B: 0 mm (0 in.)
- With bare sheet metal:
- A1: 0 mm (0 in.)
 - A2: 0 mm (0 in.)
 - B: 5 mm (0.19 in.)

Minimum Clearance for PowerPact B with Long Terminal Shields

The minimum clearance distances required around circuit breakers equipped with long terminal shields are shown below.

2P

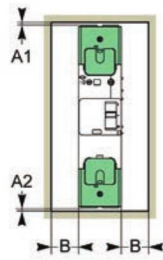

With painted sheet metal:

- A1: 0 mm (0 in.)
- A2: 0 mm (0 in.)
- B: 0 mm (0 in.)

With bare sheet metal:

- A1: 0 mm (0 in.)
- A2: 0 mm (0 in.)
- B: 5 mm (0.19 in.)

3P/4P

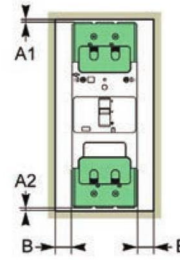

With painted sheet metal:

- A1: 0 mm (0 in.)
- A2: 0 mm (0 in.)
- B: 0 mm (0 in.)

With bare sheet metal:

- A1: 0 mm (0 in.)
- A2: 0 mm (0 in.)
- B: 5 mm (0.19 in.)

Minimum Clearance for PowerPact B with Live Parts

The minimum clearance distances required around circuit breakers using busbars are shown below.

		1P	2P	3P/4P
E ≤ 60 mm (2.36 in.)	U ≤ 690 V	<ul style="list-style-type: none"> • D1: 200 mm (7.87 in.) • D2: 100 mm (3.94 in.) 	<ul style="list-style-type: none"> • D1: 200 mm (7.87 in.) • D2: 100 mm (3.94 in.) 	<ul style="list-style-type: none"> • D1: 200 mm (7.87 in.) • D2: 100 mm (3.94 in.)
E > 60 mm (2.36 in.)	U ≤ 690 V	<ul style="list-style-type: none"> • D1: 120 mm (4.72 in.) • D2: 60 mm (2.36 in.) 	<ul style="list-style-type: none"> • D1: 120 mm (4.72 in.) • D2: 60 mm (2.36 in.) 	<ul style="list-style-type: none"> • D1: 120 mm (4.72 in.) • D2: 60 mm (2.36 in.)

Minimum Clearance Between PowerPact B Backplate and Uninsulated Power Connectors

For all types of PowerPact B-frame circuit breakers that use uninsulated power connections (for example, busbars, spreaders, or uninsulated crimped lugs), the minimum clearance distance with the enclosure backplate is shown below.

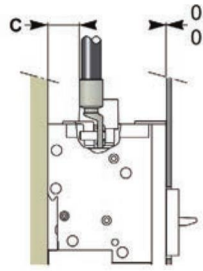

A rear insulation screen or long terminal shield is required if the distance C is less than 12.7 mm (0.5 in) for all circuit breakers.

Operating PowerPact B-Frame Devices

Operating a Circuit Breaker with a Toggle Handle

Description of a Circuit Breaker with a Toggle Handle

PowerPact B Front Face with Toggle Handle

The following figure shows the controls and indicators for a 3-pole unit mount circuit breaker with a toggle handle. The location of controls and indicators may differ for the other types of circuit breakers. Information about the other parts of the front face is available in the general description (see *Unit-Mount Circuit Breaker Description, page 11*).

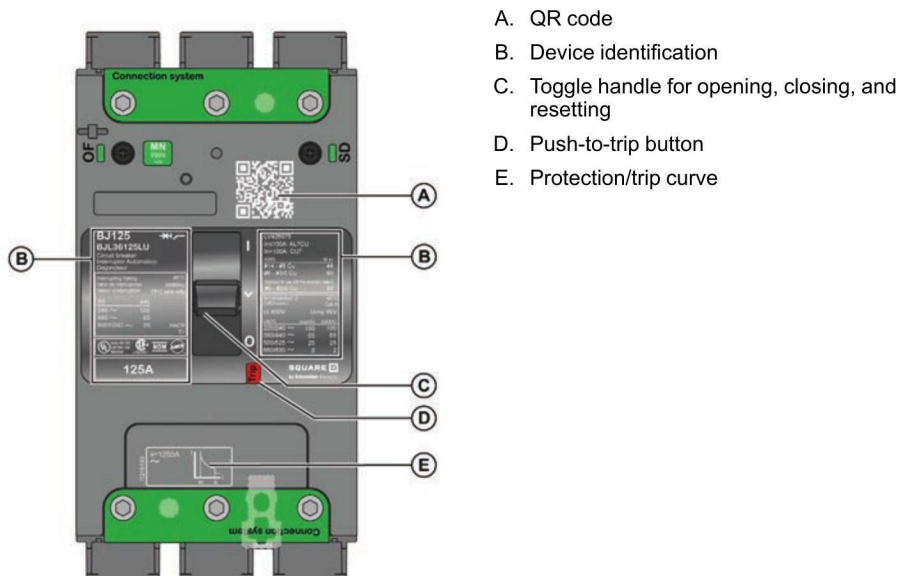

Device Identification for PowerPact B with Toggle Handle

The following figure shows an example of the device identification

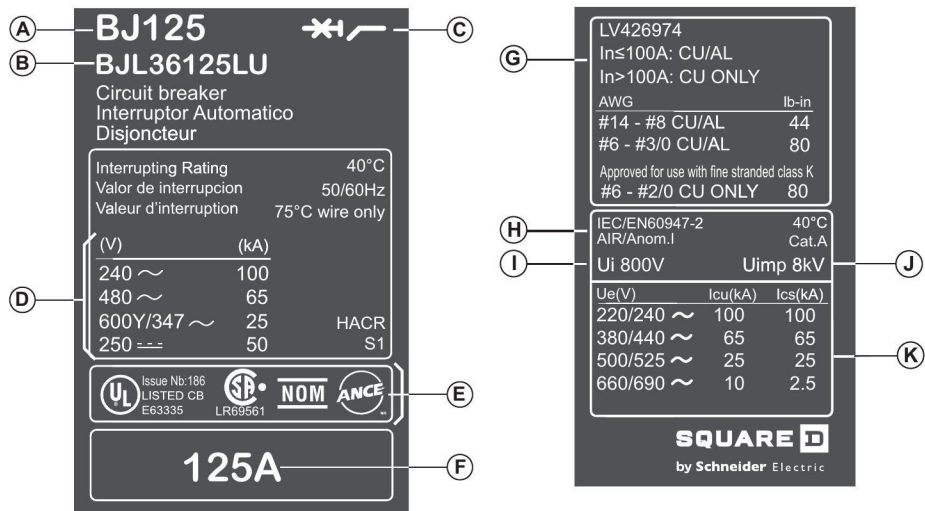

- A. Circuit breaker type
- B. Commercial reference
- C. Circuit breaker symbol
- D. UL interrupting rating
- E. Certification marks
- F. Frame rating
- G. Termination characteristics
- H. Reference standard
- I. Ui: rated insulation voltage
- J. Uimp: rated impulse withstand voltage
- K. IEC interrupting ratings, according to operating voltage Ue:
 lcu: Ultimate breaking capacity
 lcs: Service breaking capacity
 lcu: Ultimate breaking capacity
 lcs: Service breaking capacity

QR Code

Scan the QR code to get additional information about the circuit breaker from the Schneider Electric web site. To scan the QR code, use a smartphone that is equipped with a camera and installed with a QR code reader.

Opening, Closing, Resetting and Testing a Circuit Breaker with Toggle Handle

Opening and Closing with the Toggle Handle

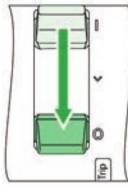
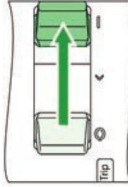
Task	Action	
Open the circuit breaker	Push the toggle handle from the I (ON) position to the O (OFF) position.	
Close the circuit breaker	Push the toggle handle from the O (OFF) position to the I (ON) position	

Resetting with the Toggle Handle After a Trip

When the circuit breaker trips, the toggle handle moves from the I (ON) position to the (Trip) position.

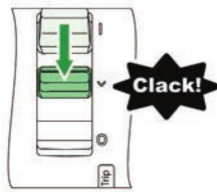

⚠ CAUTION
HAZARD OF CLOSING ON ELECTRICAL FAULT
Do not close the circuit breaker without first inspecting and, if necessary, repairing the downstream electrical equipment.
Failure to follow these instructions can result in injury or equipment damage.

The fact that a circuit breaker has tripped does not fix the cause of the fault detected on the downstream electrical equipment.

Follow these steps to reset the circuit breaker after a trip caused by an electrical fault.

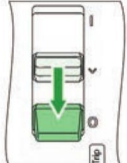
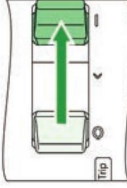
Step	Action		Position
1	Push the toggle handle from the (Trip) position to the O (OFF) position. The circuit breaker is open. https://www.schneider-electric.us/en/download/		O (OFF)
2	Take precautions to protect yourself (see <i>Taking Precautions Before Responding to a Trip</i> , page 76).	—	O (OFF)
3	Look for the cause of the detected fault (see <i>Identifying the Cause of the Trip</i> , page 76).	—	O (OFF)
4	Clean and test the downstream equipment and the circuit breaker (see <i>Checking Equipment After a Trip</i> , page 77).	—	O (OFF)
5	Push the toggle handle from the O (OFF) position to the I (ON) position. The circuit breaker is closed.		I (ON)

Testing the Trip Mechanism with a Toggle Handle

⚠ CAUTION
<p>HAZARD OF NUISANCE TRIPPING</p> <p>Circuit breaker tests must only be done by qualified electrical personnel.</p> <p>Failure to follow these instructions can result in injury or equipment damage.</p>

When testing the trip mechanism, take precautions against:

- Disrupting operations
- Activating inappropriate alarms
- Triggering unwanted actions

For example, tripping the circuit breaker with the push-to-trip button can lead to inappropriate fault indications or corrective actions (such as switching to an alternate power source).

Follow these steps to test the trip mechanism.

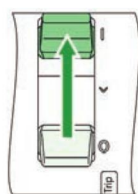
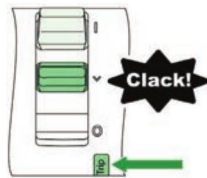
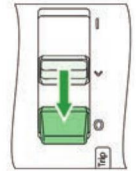
Step	Action		Position
1	<p>Push the toggle handle from the O (OFF) position to the I (ON) position.</p> <p>The circuit breaker is closed.</p>		I (ON)
2	<p>Press the push-to-trip button.</p> <p>The handle moves from the I (ON) position to the (Trip) position. The circuit breaker is tripped.</p>		(Trip)
3	<p>Push the toggle handle from the (Trip) position to the O (OFF) position.</p> <p>The circuit breaker is reset.</p>		O (OFF)

Locking of a Circuit Breaker with a Toggle Handle

Locking Options for the Toggle Handle

⚡ ⚠ DANGER

HAZARD OF ELECTRIC SHOCK, EXPLOSION, OR ARC FLASH

When the circuit breaker handle is locked in the O (OFF) position, always use a properly rated voltage sensing device to confirm power is off before working on equipment.

Failure to follow these instructions will result in death or serious injury.

NOTE: Locking the handle in the I (ON) position does not disable the circuit breaker. If an electrical fault is detected, the circuit breaker trips. When the handle is unlocked, it moves to the tripped position. To return the circuit breaker to service, reset the circuit breaker (see *Resetting with the Toggle Handle After a Trip*, page 30).

The following accessories can be used to lock the toggle handle:

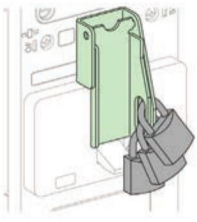
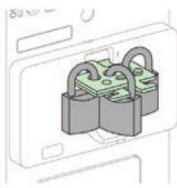
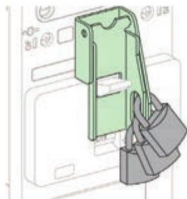
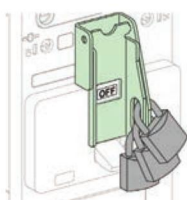
Locked Position	Lock Type	Lock Characteristics	Lock Image
O (OFF)	Fixed: the device cannot be removed from the case.	Up to 3 padlocks (not supplied) Diameter 4–8 mm (3/16–5/16 in.)	
O (OFF)	Removable: the device can be removed from the case.	Up to 3 padlocks (not supplied) Diameter 4–8 mm (3/16–5/16 in.)	
I (ON) or O (OFF)	Fixed: the device cannot be removed from the case.	Up to 3 padlocks (not supplied) Diameter 4–8 mm (3/16–5/16 in.)	Locked in the I (ON) position. 
			Locked in the O (OFF) position. 

Operating a Circuit Breaker with a Direct Rotary Handle

Description of a Circuit Breaker with a Direct Rotary Handle

PowerPact B Front Face with Direct Rotary Handle

The following figure shows the controls and indicators for a 3-pole unit mount circuit breaker with a direct rotary handle. The location of controls and indicators may differ for the other types of circuit breakers.

Information about the other parts of the front face is available in the general description (see *Unit-Mount Circuit Breaker Description*, page 11).

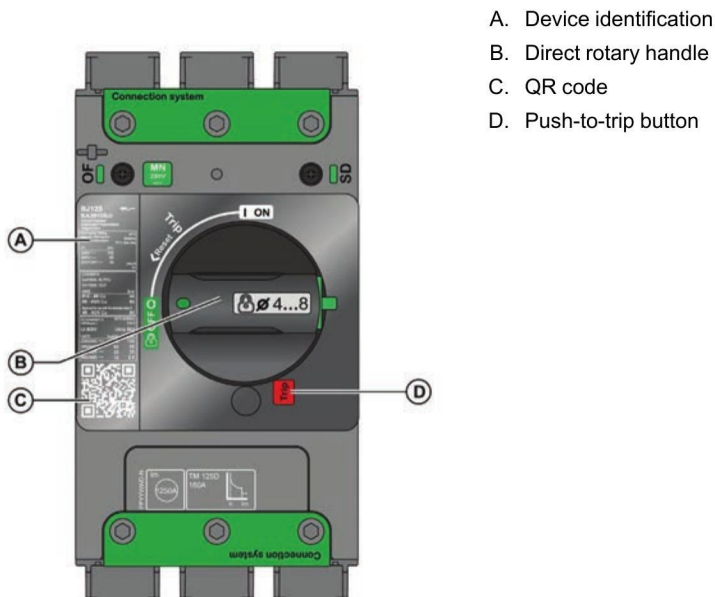

- A. Device identification
- B. Direct rotary handle
- C. QR code
- D. Push-to-trip button

Device Identification for PowerPact B with Direct Rotary Handle

The following figure shows an example of the device identification for a circuit breaker with a direct rotary handle. Your circuit breaker may have different values.

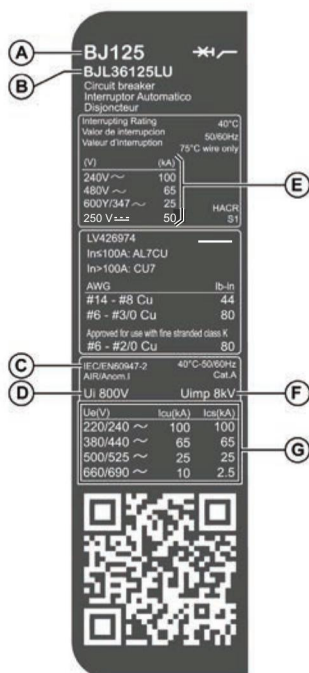

- A. Circuit breaker type
- B. Commercial reference
- C. IEC reference standard
- D. Ui rated insulation voltage
- E. UL interrupting rating
- F. Uimp: rated impulse withstand voltage
- G. IEC interrupting ratings, according to operating voltage
Ue: Icu: Ultimate breaking capacity
Ics: Service breaking capacity

QR Code

Scan the QR code to get additional information about the circuit breaker from the Schneider Electric web site. To scan the QR code, use a smartphone that is equipped with a camera and installed with a QR code reader.

Opening, Closing, Resetting and Testing a Circuit Breaker with a Direct Rotary Handle

Opening and Closing with a Direct Rotary Handle

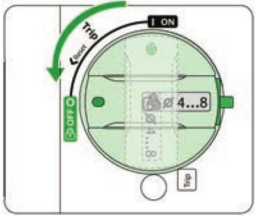
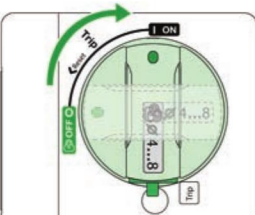
Task	Action	
Open the circuit breaker.	Turn the rotary handle from the I (ON) position to the O (OFF) position.	
Close the circuit breaker.	Turn the rotary handle from the O (OFF) position to the I (ON) position.	

Resetting with the Direct Rotary Handle After a Trip

When the circuit breaker trips, the rotary handle moves from the I (ON) position to the Trip position.

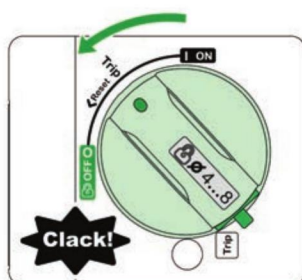

⚠ CAUTION
<p>HAZARD OF CLOSING ON ELECTRICAL FAULT</p> <p>Do not close the circuit breaker without first inspecting and, if necessary, repairing the downstream electrical equipment.</p> <p>Failure to follow these instructions can result in injury or equipment damage.</p>

The fact that a circuit breaker has tripped does not fix the cause of the fault detected on the downstream electrical equipment.

Follow these steps to reset the circuit breaker after a trip caused by an electrical fault.

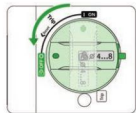
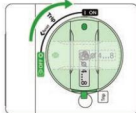
Step	Action		Position
1	Turn the rotary handle from the Trip position to the O (OFF) position. The circuit breaker resets and is open.		O (OFF)
2	Take precautions to protect yourself (see <i>Taking Precautions Before Responding to a Trip</i> , page 76).	—	O (OFF)
3	Look for the cause of the detected fault (see <i>Identifying the Cause of the Trip</i> , page 76).	—	O (OFF)
4	Clean and test the downstream equipment and the circuit breaker (see <i>Checking Equipment After a Trip</i> , page 77).	—	O (OFF)
5	Turn the rotary handle from the O (OFF) position to the I (ON) position. The circuit breaker is closed.		I (ON)

Testing the Trip Mechanism with a Direct Rotary Handle

⚠ CAUTION
HAZARD OF NUISANCE TRIPPING
Circuit breaker tests must only be done by qualified electrical personnel.
Failure to follow these instructions can result in injury or equipment damage.

When testing the trip mechanism, take precautions against:

- Disrupting operations
- Activating inappropriate alarms
- Triggering unwanted actions

For example, tripping the circuit breaker with the push-to-trip button can lead to inappropriate fault indications or corrective actions (such as switching to an alternate power source).

Follow these steps to test the trip mechanism.

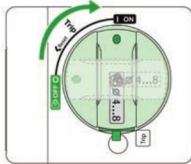
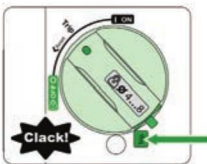
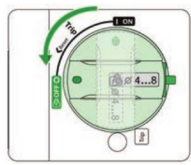
Step	Action		Position
1	Turn the rotary handle from the O (OFF) position to the I (ON) position. The circuit breaker is closed.		I (ON)
2	Press the push-to-trip button. The handle moves from the I (ON) position to the (Trip) position. The circuit breaker is tripped.		(Trip)
3	Turn the rotary handle from the Trip position to the O (OFF) position. The circuit breaker is reset.		O (OFF)

Locking a Circuit Breaker with a Direct Rotary Handle

Locking Options for the Direct Rotary Handle

⚠️ ⚠️ DANGER

HAZARD OF ELECTRIC SHOCK, EXPLOSION, OR ARC FLASH

When the circuit breaker handle is locked in the O (OFF) position, always use a properly rated voltage sensing device to confirm power is off before working on equipment.

Failure to follow these instructions will result in death or serious injury.

The direct rotary handle offers the following locking options:

- Prevent the door from being opened if the door interlock was activated at installation time
- Prevent the rotary handle from being operated

The handle can be locked in the O (OFF) or I (ON) position.

No setup is required to lock the handle in the O (OFF) position.

Before the handle can be locked in the I (ON) position, the rotary handle block must be dismantled and the physical setup of the handle must be changed. This is usually done at installation. For information about how to set up the handle to be locked in the I (ON) position, see the relevant instruction sheet (see *Related Documents, page 8*).

NOTE: Locking the rotary handle in the I (ON) position does not disable the circuit breaker. If an electrical fault is detected, the circuit breaker still trips. When the rotary handle is unlocked, it moves to the Trip position.

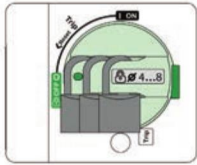
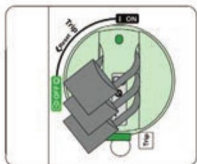
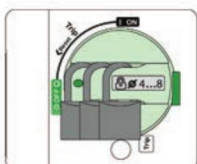
Locked Position	Lock Type	Lock Characteristics	Lock Image
O (OFF)	Standard padlocking	Up to 3 padlocks (not supplied) Diameter: 4–8 mm (3/16–5/16 in.)	
I (ON) or O (OFF)	Padlocking after modification of the rotary handle during installation	Up to 3 padlocks (not supplied) Diameter: 4–8 mm (3/16–5/16 in.)	
			

Inserting Padlocks in the PowerPact B Rotary Handle

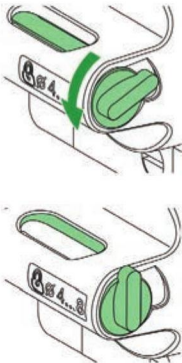
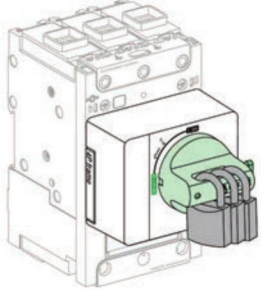
Step	Action	Comment
1	With the handle in the O (OFF) or I (ON) position, turn the knob as illustrated until the slot in the handle opens.	
2	Insert the padlocks in the slot.	

Overriding the Rotary Handle Door Interlock

⚡ ⚠ **DANGER**

HAZARD OF ELECTRIC SHOCK, EXPLOSION, OR ARC FLASH

Overriding the door interlock must only be done by qualified electrical personnel.

Failure to follow these instructions will result in death or serious injury.

If it was activated at the time of installation, the interlock between the door and the circuit breaker allows the door to be opened only when the circuit breaker is open and the rotary handle is in the O (OFF) position.

When the rotary handle is in the I (ON) position or the Trip position, the door interlock prevents the door from opening. To open the door, the handle must be turned to the O (OFF) position.

Under exceptional circumstances, qualified electrical personnel can follow these steps to open the door while the rotary handle is in the I (ON) position or the Trip position:

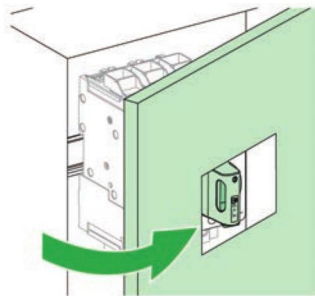
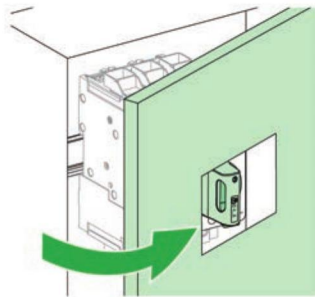
Step	Action	
1	Using a screwdriver, turn the locking screw clockwise by 10-15 degrees and then hold the screwdriver in place.	
2	Still holding the screwdriver in place, open the door and then release the locking screw.	

To close the door, use a screwdriver to turn the locking screw clockwise by 10-15 degrees. Holding the screwdriver in place, close the door and then release the locking screw.

Operating a Circuit Breaker with a Front Extended Rotary Handle

Description of a Circuit Breaker with a Front Extended Rotary Handle

PowerPact B Front Face with Front Extended Handle

The controls, indicators, and locking mechanism are located on the following parts of the circuit breaker:

- The operating control is on the enclosure door.
- The operation indicators are on the circuit breaker and on the door plate.
- The locking mechanism is on the circuit breaker (door open) or on the door plate (door closed).

To operate the circuit breaker when the door is open, use an open door shaft operator, available as an accessory.

The following figures show the controls and indicators for a circuit breaker with a front extended rotary handle. Information about the other parts of the front face is available in the general description (see *Unit-Mount Circuit Breaker Description, page 11*).

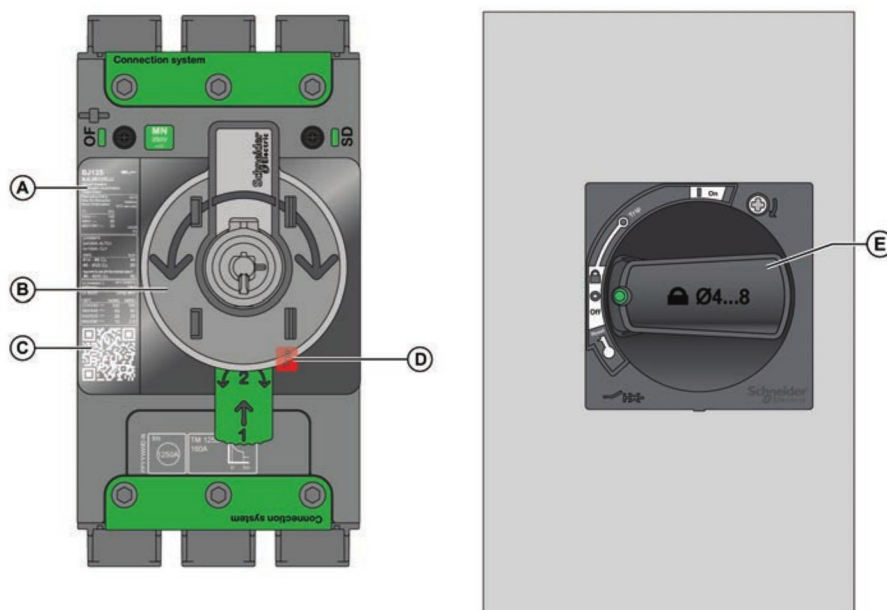

- A. Device identification
- B. Open door shaft operator
- C. QR code
- D. Push-to-trip button
- E. Door operator

Device Identification for PowerPact B with Front Extended Handle

Information about the circuit breaker is given on the device identification label (see *Device Identification for PowerPact B with Direct Rotary Handle, page 33*).

QR Code

Scan the QR code to get additional information about the circuit breaker from the Schneider Electric web site. To scan the QR code, use a smartphone that is equipped with a camera and installed with a QR code reader.

Opening, Closing, Resetting and Testing a Circuit Breaker with a Front Extended Rotary Handle

Opening and Closing with the Front Extended Handle

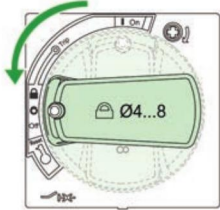
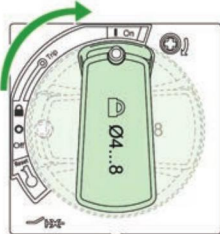
Task	Action	
Open the circuit breaker	Push the rotary handle from the I (ON) position to the O (OFF) position.	
Close the circuit breaker	Push the rotary handle from the O (OFF) position to the I (ON) position	

Resetting with the Front Extended Handle After a Trip

When the circuit breaker trips, the rotary handle moves from the I (ON) position to the (Trip) position.

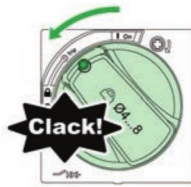

⚠ CAUTION
HAZARD OF CLOSING ON ELECTRICAL FAULT
Do not close the circuit breaker without first inspecting and, if necessary, repairing the downstream electrical equipment.
Failure to follow these instructions can result in injury or equipment damage.

The fact that a circuit breaker has tripped does not fix the cause of the fault detected on the downstream electrical equipment.

Follow these steps to reset the circuit breaker after a trip caused by an electrical fault.

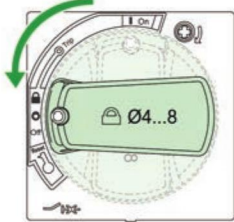
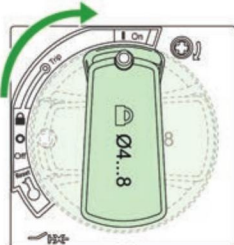
Step	Action		Position
1	Push the toggle handle from the (Trip) position to the O (OFF) position. The circuit breaker is open.		O (OFF)
2	Take precautions to protect yourself (see <i>Taking Precautions Before Responding to a Trip</i> , page 76).	—	O (OFF)
3	Look for the cause of the detected fault (see <i>Identifying the Cause of the Trip</i> , page 76).	—	O (OFF)
4	Clean and test the downstream equipment and the circuit breaker (see <i>Checking Equipment After a Trip</i> , page 77).	—	O (OFF)
5	Push the handle from the O (OFF) position to the I (ON) position. The circuit breaker is closed.		I (ON)

Testing the Trip Mechanism with a Front Extended Handle

⚠ CAUTION
<p>HAZARD OF NUISANCE TRIPPING</p> <p>Circuit breaker tests must only be done by qualified electrical personnel.</p> <p>Failure to follow these instructions can result in injury or equipment damage.</p>

When testing the trip mechanism, take precautions against:

- Disrupting operations
- Activating inappropriate alarms
- Triggering unwanted actions

For example, tripping the circuit breaker with the push-to-trip button can lead to inappropriate fault indications or corrective actions (such as switching to an alternate power source).

There is no push-to-trip button on the door of a circuit breaker with a front extended rotary handle. To check the trip mechanism, the door must first be opened.

Follow these steps to test the trip mechanism.

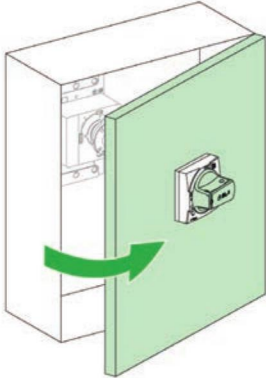
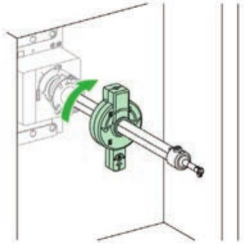
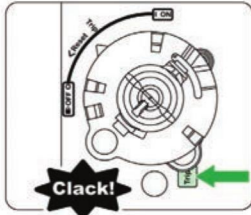
Step	Action		Position
1	With the circuit breaker in the O (OFF) position, open the door.		O (OFF)
2	Turn the circuit breaker from the O (OFF) position to the I (ON) position, using one of the following tools: <ul style="list-style-type: none"> • An open door shaft operator (LV426937). • A flat wrench, taking care not to damage the extension shaft or its surface treatment. The extension shaft is a hollow rectangular tube, 15 x 10 mm (0.59 x 0.39 in.). The circuit breaker is ready for the test.		I (ON)
3	Press the push-to-trip button. The circuit breaker trips.		Trip

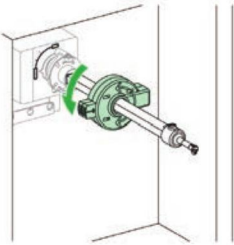
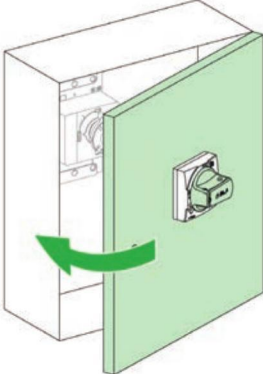
Step	Action		Position
4	Turn the circuit breaker from the Trip position to the O (OFF) position. The circuit breaker is open.		O (OFF)
5	Close the door.		—

Locking a Circuit Breaker with a Front Extended Rotary Handle

Locking Options for the Front Extended Handle

⚠️ ⚠️ DANGER

HAZARD OF ELECTRIC SHOCK, EXPLOSION, OR ARC FLASH

When the circuit breaker handle is locked in the O (OFF) position, always use a properly rated voltage sensing device to confirm power is off before working on equipment.

Failure to follow these instructions will result in death or serious injury.

The extended rotary handle offers the following locking options:



- Prevent the door from being opened
- Prevent the rotary handle from being operated
- Prevent the circuit breaker itself from being operated

The handle can be locked in the O (OFF) position or, in the case of the black door operator, in the I (ON) position.

No setup is required to lock the handle in the O (OFF) position.

Before the handle can be locked in the I (ON) position, the door operator must be dismounted and the physical setup of the handle must be changed. This is usually done at installation. For information about how to set up the handle to be locked in the I (ON) position, see the relevant instruction sheet (see *Related Documents*, page 8).

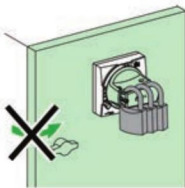
NOTE: Locking the rotary handle in the I (ON) position does not disable the circuit breaker. If there is a fault detection, the circuit breaker still trips. When the rotary handle is unlocked, it moves to the Trip position.

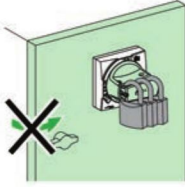
Locked Position	Lock Type	Lock Characteristics	Lock Image
O (OFF)	Standard padlocking	Up to 3 padlocks (not supplied) Diameter 4–8 mm (3/16–5/16 in.)	
I (ON) or O (OFF) (Black door operator only)	Padlocking after modification of the door operator during installation	Up to 3 padlocks (not supplied) Diameter 4–8 mm (3/16–5/16 in.)	
			

Inserting Padlocks in the Extended Rotary Handle

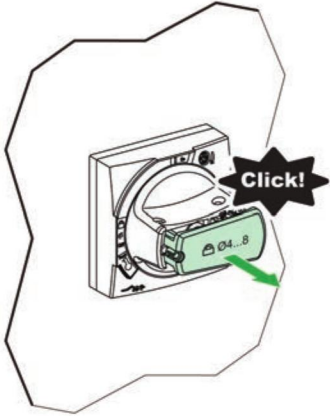
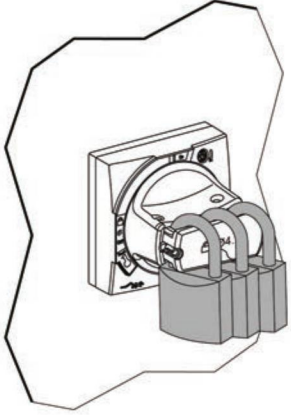
Step	Action	Comment
1	<p>With the handle in the O (OFF) or I (ON) position, pull the cover on the front of the handle until you hear a click.</p> <p>A space opens between the handle and the cover.</p>	
2	<p>Insert the padlocks in the space.</p>	

Locking the Circuit Breaker with an Extended Rotary Handle in the O (OFF) Position When the Door is Open

The following procedure explains how to lock the circuit breaker itself, instead of the handle.

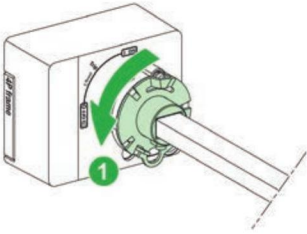
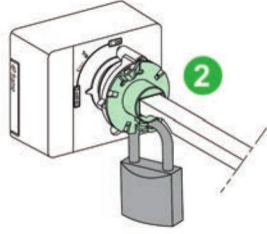
Step	Action	Comment
1	<p>With the circuit breaker in the O (OFF) position, turn the locking plate counter-clockwise by 60 degrees to align the holes for the lock.</p>	
2	<p>Put a padlock or safety lockout hasp (4–8 mm, 3/16–5/16 in.) in the hole to lock the circuit breaker in the O (OFF) position.</p>	

Overriding the Extended Rotary Handle Door Interlock

⚡ ⚠ **DANGER**

HAZARD OF ELECTRIC SHOCK, EXPLOSION, OR ARC FLASH

Overriding the door interlock must only be done by qualified electrical personnel.

Failure to follow these instructions will result in death or serious injury.

An interlock between the door and the circuit breaker position allows you to open the door only when the circuit breaker is open and the rotary handle is in the **O (OFF)** position.

When the rotary handle is in the **I (ON)** position or the **Trip** position, the door interlock prevents you from opening the door. To open the door, you must turn the handle to the **O (OFF)** position.

Under exceptional circumstances, qualified electrical personnel can follow these steps to open the door while the rotary handle is in the **I (ON)** position or the **Trip** position:

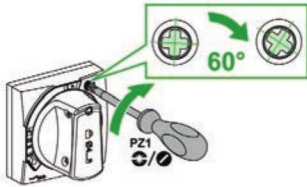
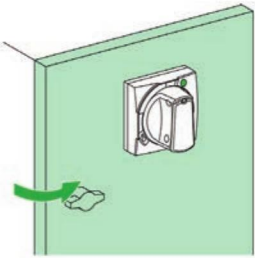
Step	Action	
1	Using a screwdriver, turn the locking screw clockwise by 60 degrees and hold the screwdriver in place.	
2	Open the door.	

To close the door, use a screwdriver to turn the locking screw clockwise by 60 degrees. Holding the screwdriver in place, close the door and then release the locking screw.

Operating a Circuit Breaker with a Side Rotary Handle

Description of a Circuit Breaker with a Side Rotary Handle

PowerPact B Front Face with Side Rotary Handle

The controls, indicators, and locking mechanism are located on the following parts of the circuit breaker:

- The operating control is on the side plate.
- The operation indicators are on the circuit breaker and on the side plate.
- The locking mechanism is on the side plate.

The following figure shows the controls and indicators for a circuit breaker with a side rotary handle.

Information about the other parts of the front face is available in the general description (see *Unit-Mount Circuit Breaker Description, page 11*).

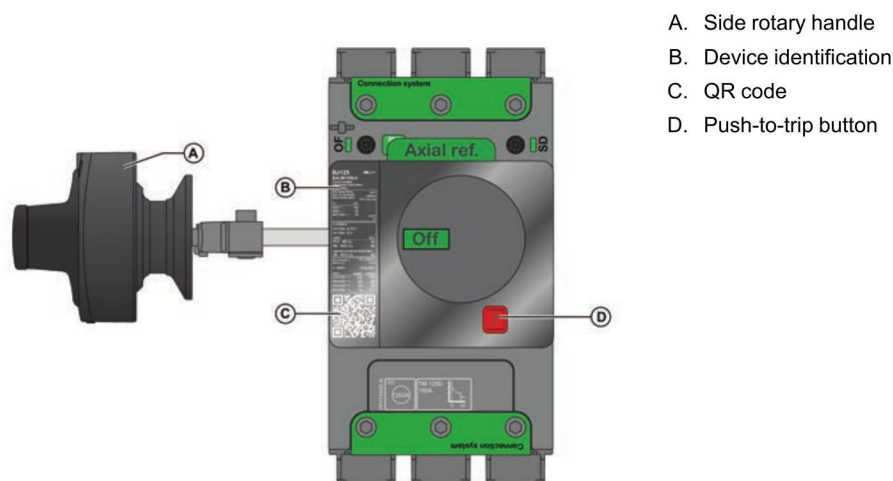

Device Identification for PowerPact B with Side Rotary Handle

Information about the circuit breaker is given on the device identification label (see *Device Identification for PowerPact B with Direct Rotary Handle, page 33*).

QR Code

Scan the QR code to get additional information about the circuit breaker from the Schneider Electric web site. To scan the QR code, use a smartphone that is equipped with a camera and installed with a QR code reader.

Opening, Closing, Resetting and Testing a Circuit Breaker with a Side Rotary Handle

Opening and Closing with the Side Rotary Handle

Open and close a circuit breaker with a side rotary handle in the same way as for a circuit breaker with an extended rotary handle (see *Opening and Closing with the Front Extended Handle*, page 41).

Resetting with the Side Rotary Handle After a Trip

After a trip, reset a circuit breaker with a side rotary handle in the same way as for a circuit breaker with an extended rotary handle (see *Resetting with the Front Extended Handle After a Trip*, page 42).

Testing the Trip Mechanism with a Side Rotary Handle

⚠ CAUTION
HAZARD OF NUISANCE TRIPPING
Circuit breaker tests must only be done by qualified electrical personnel.
Failure to follow these instructions can result in injury or equipment damage.

When testing the trip mechanism, take precautions against:



- Disrupting operations
- Activating inappropriate alarms
- Triggering unwanted actions

For example, tripping the circuit breaker with the push-to-trip button can lead to inappropriate fault indications or corrective actions (such as switching to an alternate power source).

There is no push-to-trip button on the door of a circuit breaker with a side rotary handle. To check the trip mechanism, the door must first be opened.

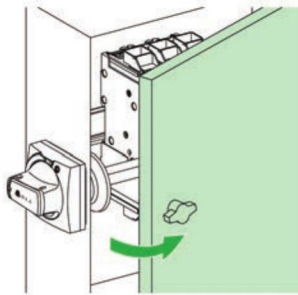
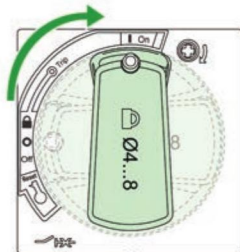
Follow these steps to test the trip mechanism.

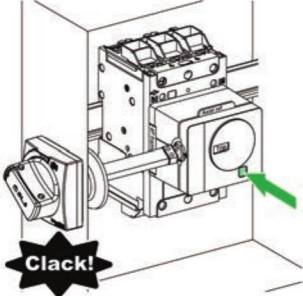
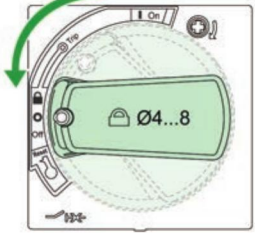
Step	Action		Position
1	With the circuit breaker in the O (OFF) position, open the enclosure door. O (OFF)		O (OFF)
2	Turn the circuit breaker from the O (OFF) position to the I (ON) position. The circuit breaker is ready for the test.		I (ON)

Step	Action		Position
3	Press the push-to-trip button. The circuit breaker trips.		Trip
4	Turn the circuit breaker from the Trip position to the O (OFF) position. The circuit breaker is open.		O (OFF)
5	Close the door.		—

Locking a Circuit Breaker with a Side Rotary Handle

Locking Options for the Side Rotary Handle

⚠️ ⚠️ DANGER

HAZARD OF ELECTRIC SHOCK, EXPLOSION, OR ARC FLASH

When the circuit breaker handle is locked in the **O (OFF)** position, always use a properly rated voltage sensing device to confirm power is off before working on equipment.

Failure to follow these instructions will result in death or serious injury.

The side rotary handle offers a locking option to prevent the rotary handle from being operated.

The handle can be locked in the **O (OFF)** position or, in the case of the black side operator, in the **I (ON)** position.

No setup is required to lock the handle in the **O (OFF)** position.

Before the handle can be locked in the **I (ON)** position, the side operator must be dismantled and the physical setup of the handle must be changed. This is usually done at installation. For information about how to set up the handle to be locked in the **I (ON)**, position, see the relevant instruction sheet (see *Related Documents*, page 8).

NOTE: Locking the rotary handle in the **I (ON)** position does not disable the circuit breaker. If there is a fault detection, the circuit breaker still trips. When the rotary handle is unlocked, it moves to the **Trip** position.

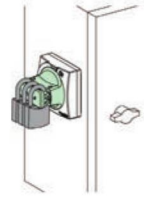
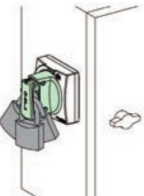
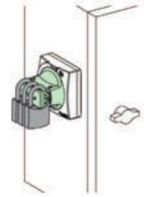
Locked Position	Lock Type	Lock Characteristics	Lock Image
O (OFF)	Standard padlocking	Up to 3 padlocks (not supplied) Diameter 4–8 mm (3/16–5/16 in.)	
I (ON) or O (OFF) (Black side operator only)	Padlocking after modification of the side operator during installation	Up to 3 padlocks (not supplied) Diameter 4–8 mm (3/16–5/16 in.)	
			

Inserting Padlocks in Side Rotary Handle

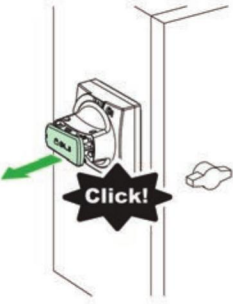
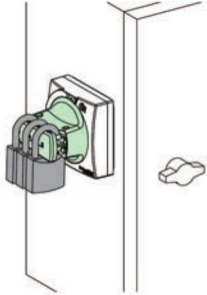
Step	Action	Comment
1	<p>With the handle in the O (OFF) or I (ON) position, pull the cover on the front of the handle until you hear a click.</p> <p>A space opens between the handle and the cover.</p>	
2	<p>Insert the padlocks in the space.</p>	

Operating a Circuit Breaker with a 9421 Rotary Handle

Description of a Circuit Breaker with a 9421 Rotary Handle

Class 9421 Circuit Breaker Operating Mechanism

Class 9421 Type L circuit breaker operating mechanisms are heavy-duty all-metal construction mechanisms with trip indication. When the enclosure door is open, the operating mechanism can be padlocked in the O (OFF) position. When the enclosure door is closed, the handle can be locked in the O (OFF) position, which also locks the door closed.

The 6-inch handles accept up to three padlocks. The 3-inch handles accept one padlock.

Complete Kits for Class 9421 Operating Mechanism

Complete kits are rated for NEMA Type 1, 3R and 12 enclosures, and a door-drilling template is supplied to ease installation. The kits include a handle assembly, operating mechanism, and shaft assembly.

PowerPact B Front Face with 9421 Rotary Handle

The controls, indicators, and locking mechanism are located as follows:

- The operating control is on the enclosure door.
- The operation indicators are on the circuit breaker and on the door plate.
- The locking mechanism is on the circuit breaker (door open) or on the door plate (door closed).

The following figure shows the Class 9421 circuit breaker operating mechanism.

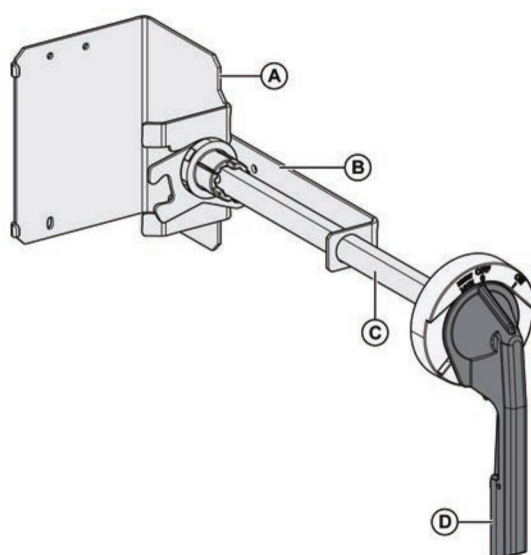

- A. Operating mechanism
- B. Long shaft support bracket
- C. Long shaft
- D. Standard 6-inch handle

Device Identification for PowerPact B with 9421 Rotary Handle

Information about the circuit breaker is given on the device identification label (see *Description of a Circuit Breaker with a Direct Rotary Handle*, page 33).

QR Code

Scan the QR code to get additional information about the circuit breaker from the Schneider Electric web site. To scan the QR code, use a smartphone that is equipped with a camera and installed with a QR code reader.

Opening, Closing, Resetting and Testing a Circuit Breaker with a 9421 Rotary Handle

Opening and Closing with the 9421 Rotary Handle

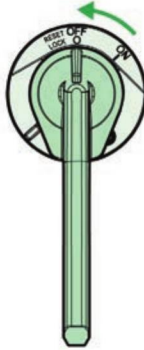
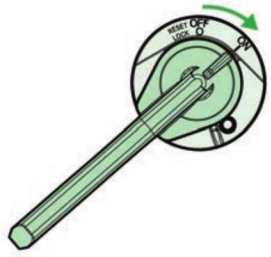
Task	Action	
Open the circuit breaker	Turn the operating mechanism from the I (ON) position to the O (OFF) position.	
Close the circuit breaker	Turn the operating mechanism from the O (OFF) position to the I (ON) position.	

Resetting with the 9421 Rotary Handle After a Trip

When the circuit breaker trips, the operating mechanism moves from the **I (ON)** position to the **O (OFF)** position.

⚠ CAUTION
HAZARD OF CLOSING ON ELECTRICAL FAULT
Do not close the circuit breaker without first inspecting and, if necessary, repairing the downstream electrical equipment.
Failure to follow these instructions can result in injury or equipment damage.

The fact that a circuit breaker has tripped does not fix the cause of the fault detected on the downstream electrical equipment.

Follow these steps to reset the circuit breaker after a trip caused by an electrical fault.

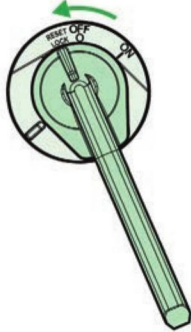
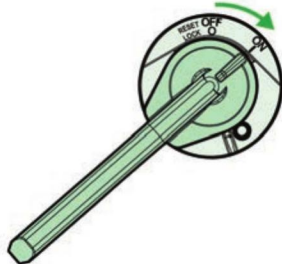
Step	Action		Position
1	Turn the handle from the O (OFF) position to the RESET/LOCK position. The circuit breaker is open.		O (OFF)
2	Take precautions to protect yourself (see <i>Taking Precautions Before Responding to a Trip</i> , page 76).	—	O (OFF)
3	Look for the cause of the detected fault (see <i>Identifying the Cause of the Trip</i> , page 76).	—	O (OFF)
4	Clean and test the downstream equipment and the circuit breaker (see <i>Checking Equipment After a Trip</i> , page 77).	—	O (OFF)
5	Turn the handle from the RESET/LOCK position to the I (ON) position. The circuit breaker is closed.		I (ON)

Testing the Trip Mechanism with a 9421 Rotary Handle

⚠ CAUTION
HAZARD OF NUISANCE TRIPPING
Circuit breaker tests must only be done by qualified electrical personnel.
Failure to follow these instructions can result in injury or equipment damage.

When testing the trip mechanism, take precautions against:

- Disrupting operations
- Activating inappropriate alarms
- Triggering unwanted actions

For example, tripping the circuit breaker with the push-to-trip button can lead to inappropriate fault indications or corrective actions (such as switching to an alternate power source).

There is no push-to-trip button on the door of a circuit breaker enclosure with a front operating mechanism.

To check the trip mechanism, the enclosure door must first be opened.

⚡ ⚠ DANGER
HAZARD OF ELECTRIC SHOCK, EXPLOSION, OR ARC FLASH
Overriding the door interlock must only be done by qualified electrical personnel.
Failure to follow these instructions will result in death or serious injury.

Follow these steps to test the trip mechanism.

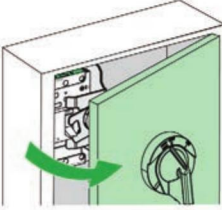
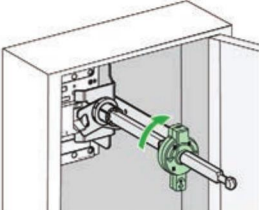
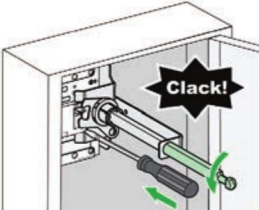
Step	Action		Position
1	With the circuit breaker in the O (OFF) position, open the door.		I (ON)
2	Turn the circuit breaker from the O (OFF) position to the I (ON) position, using one of the following tools: <ul style="list-style-type: none"> • An open door shaft operator (LV426937) • A flat wrench, taking care not to damage the extension shaft or its surface treatment The circuit breaker is ready for the test.		(Trip)
3	Press the push-to-trip button. The circuit breaker trips.		O (OFF)

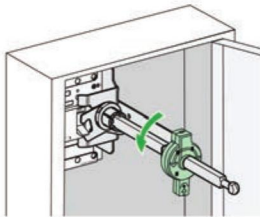
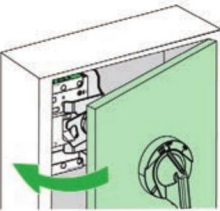
Step	Action		Position
4	Turn the circuit breaker from the tripped position to the O (OFF) position. The circuit breaker is open.		O (OFF)
5	Close the door.		—

Locking a Circuit Breaker with a 9421 Rotary Handle

Locking Options for the 9421 Rotary Handle

⚠️ ⚠️ DANGER

HAZARD OF ELECTRIC SHOCK, EXPLOSION, OR ARC FLASH

When the circuit breaker handle is locked in the O (OFF) position, always use a properly rated voltage sensing device to confirm power is off before working on equipment.

Failure to follow these instructions will result in death or serious injury.

The Class 9421 circuit breaker can be locked in the RESET/LOCK position as follows:

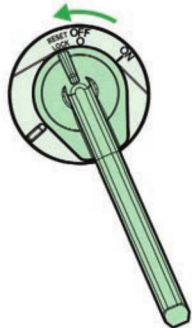

- With the door closed, by locking the rotary handle in the RESET/LOCK position (the door is also locked)
- With the door open, by locking the operating mechanism

Locked Position	Lock Type	Lock Characteristics	Accessory
RESET/LOCK	Standard padlocking	Up to 3 padlocks (not supplied) Diameter 4–8 mm (3/16–5/16 in.)	

Inserting Padlocks in the 9421 Rotary Handle

The handle can be locked in the **RESET/LOCK** position.

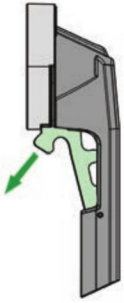
No setup is required to lock the handle in the **RESET/LOCK** position.

Step	Action	Comment
1	With the handle in the RESET/LOCK position, pull the tab under the handle until a space opens below the handle.	
2	Insert one or more padlocks in the space.	

Locking the Circuit Breaker with a 9421 Rotary Handle in the O (OFF) Position When the Door is Open

To open the enclosure door, the operating mechanism must be in the O (OFF) position. The following figure shows how to lock the circuit breaker itself, instead of the handle.

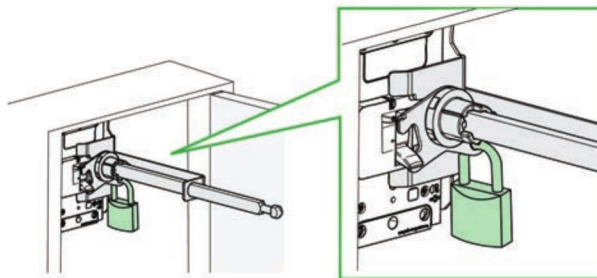

Overriding the 9421 Door Interlock

⚡ ⚠ **DANGER**

HAZARD OF ELECTRIC SHOCK, EXPLOSION, OR ARC FLASH

Overriding the door interlock must only be done by qualified electrical personnel.

Failure to follow these instructions will result in death or serious injury.

An interlock between the door and the circuit breaker position allows you to open the door only when the circuit breaker is open and the operating mechanism is in the O (OFF) position.

When the operating mechanism is in the I (ON) position, the door interlock prevents you from opening the door. To open the door, you must turn the handle to the O (OFF) position.

Under exceptional circumstances, qualified electrical personnel can follow these steps to open the door while the rotary handle is in the I (ON) position:

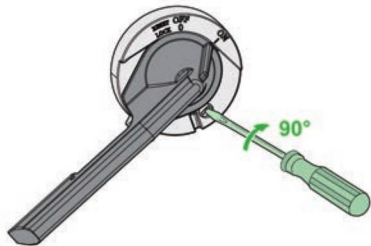
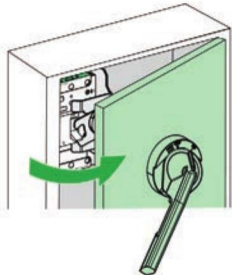
Step	Action	
1	Using a screwdriver, turn the locking screw clockwise by 90 degrees.	
2	Holding the locking screw in that position, open the door.	

NOTE: Follow the same procedure to close the door while the rotary handle is in the I (ON) position.

Operating a Circuit Breaker with a 9422 Toggle Handle

Description of a Circuit Breaker with a 9422 Toggle Handle

Class 9422 Circuit Breaker Operating Mechanism

Class 9422 Circuit Breaker Operating Mechanisms are designed for installation in custom-built control enclosures where main or branch circuit protective devices are required. All circuit breaker operating mechanisms are suitable for either right- or left-hand flange mounting and are convertible on site.

Complete 9422 Kits

Complete kits are rated for NEMA Type 1, 3R and 12 enclosures, and a door-drilling template is supplied to ease installation. They include a handle assembly, operating mechanism, and shaft assembly.

Class 9422 Flexible Cable Operating Mechanisms

For tall, deep enclosures where placement flexibility is required, it is possible to use a flexible cable operating mechanism with the Class 9422Ax handle for the PowerPact B-frame circuit breaker.

PowerPact B Front Face with 9422 Toggle Handle

The controls, indicators, and locking mechanism are located as follows:

- The operating control is on the enclosure.
- The operation indicators are on the circuit breaker and on the handle operator.
- The locking mechanism is on the handle operator.

The following figure shows the Class 9422 operating mechanism and a Class 9422 operating mechanism

with a flange-mounted toggle handle. The handle is sold separately

9422 Operating Mechanism

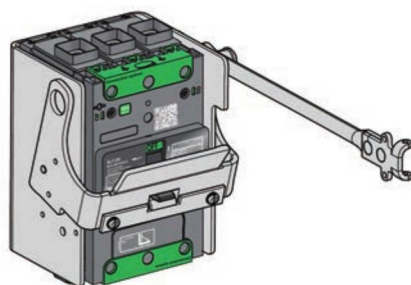

9422 Operating Mechanism with Flange-Mounted Handle

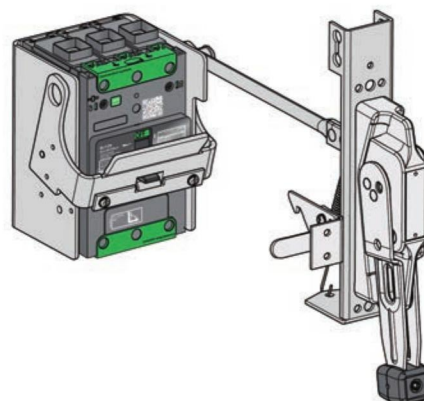

Device Identification for PowerPact B with 9422 Toggle Handle

Information about the circuit breaker is given on the device identification label (see *Description of a Circuit Breaker with a Direct Rotary Handle*, page 33).

QR Code

Scan the QR code to get additional information about the circuit breaker from the Schneider Electric web site. To scan the QR code, use a smartphone that is equipped with a camera and installed with a QR code reader.

Opening, Closing, Resetting, and Testing a Circuit Breaker with a 9422 Toggle Handle

Opening and Closing with a 9422 Toggle Handle

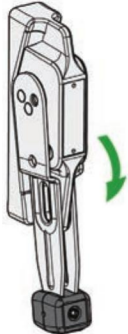
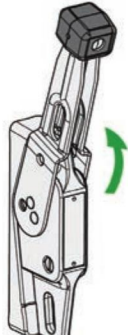
Task	Action	
Open the circuit breaker	Push the toggle handle from the I (ON) position to the O (OFF) position.	
Close the circuit breaker	Push the toggle handle from the O (OFF) position to the I (ON) position	

Resetting with the 9422 Toggle Handle After a Trip

When the circuit breaker trips, the handle either remains in the **I (ON)** position (A) or moves to a position (B) between **I (ON)** and **O (OFF)**, depending on the internal layout of the enclosure, and the cable length in relation to the operating mechanism.

To reset the circuit breaker, place the handle in the **O (OFF)** position (C).

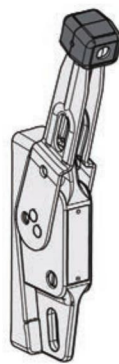

Position A
I (ON)

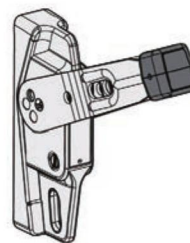

Position B

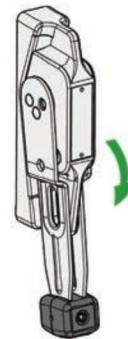



Position C
O (OFF)

Resetting the 9422 Toggle Handle After a Trip Caused by an Electrical Fault

The fact that a circuit breaker has tripped does not fix the cause of the fault detected on the downstream electrical equipment.

⚠ CAUTION
HAZARD OF CLOSING ON ELECTRICAL FAULT
Do not close the circuit breaker without first inspecting and, if necessary, repairing the downstream electrical equipment.
Failure to follow these instructions can result in injury or equipment damage.

Follow these steps to reset the circuit breaker after a trip caused by an electrical fault.

Step	Action		Position
1	Confirm that the handle is in the O (OFF) position.		O (OFF)
2	Take precautions to protect yourself (see <i>Taking Precautions Before Responding to a Trip</i> , page 76).	—	O (OFF)
3	Look for the cause of the detected fault (see <i>Identifying the Cause of the Trip</i> , page 76).	—	O (OFF)
4	Clean and test the downstream equipment and the circuit breaker (see <i>Checking Equipment After a Trip</i> , page 77).	—	O (OFF)
5	Push the toggle handle from the O (OFF) position to the I (ON) position. The circuit breaker is closed.		I (ON)

Testing the Trip Mechanism with a 9422 Toggle Handle

⚠ CAUTION
<p>HAZARD OF NUISANCE TRIPPING</p> <p>Circuit breaker tests must only be done by qualified electrical personnel.</p> <p>Failure to follow these instructions can result in injury or equipment damage.</p>

When testing the trip mechanism, take precautions against:

- Disrupting operations
- Activating inappropriate alarms
- With the circuit breaker in the O (OFF) position, open the door.

Triggering unwanted actions

For example, tripping the circuit breaker with the push-to-trip button can lead to inappropriate fault indications or corrective actions (such as switching to an alternate power source).

There is no push-to-trip button on the door of a circuit breaker with a Class 9422 circuit breaker operating

mechanism. To check the circuit breaker trip mechanism, the door must first be opened.

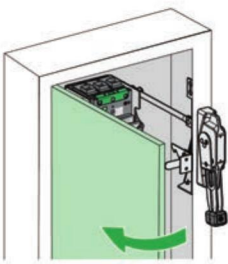
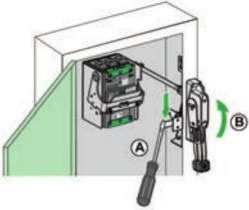
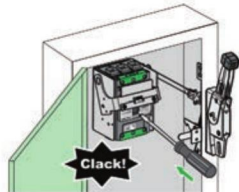
Step	Action		Position
1	With the circuit breaker in the O (OFF) position, open the door.		O (OFF)
2	Holding down the interlock bar (A), turn the circuit breaker from the O (OFF) position to the I (ON) position. The circuit breaker is ready for the test.		I (ON)
3	Press the push-to-trip button. The circuit breaker trips.		Trip

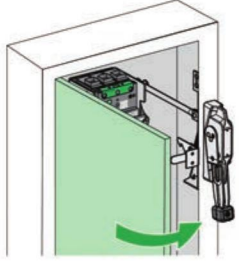
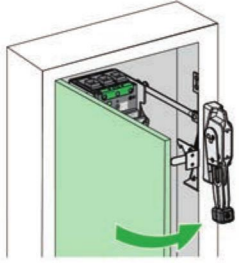
Step	Action		Position
4	Turn the circuit breaker O (OFF).		O (OFF)
5	Close the door.		—

Locking a Circuit Breaker with a 9422 Toggle Handle

Locking Options for the 9422 Toggle Handle

⚠️ ⚠️ DANGER

HAZARD OF ELECTRIC SHOCK, EXPLOSION, OR ARC FLASH

When the circuit breaker handle is locked in the O (OFF) position, always use a properly rated voltage sensing device to confirm power is off before working on equipment.

Failure to follow these instructions will result in death or serious injury.

The Class 9422 circuit breaker operating mechanism can only be locked by locking the handle. The handle can be locked in the **O (OFF)** position only.

Padlocks can be used to lock the handle:

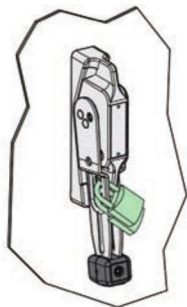
Locked Position	Lock Type	Lock Characteristics	Lock Image
O (OFF)	Standard padlocking.	Up to 3 padlocks (not supplied) Diameter 4–8 mm (3/16–5/16 in.)	

Overriding the 9422 Door Interlock

⚡ ⚠ DANGER

HAZARD OF ELECTRIC SHOCK, EXPLOSION, OR ARC FLASH

Overriding the door interlock must only be done by qualified electrical personnel.

Failure to follow these instructions will result in death or serious injury.

An interlock between the door and the circuit breaker position allows you to open the door only when the circuit breaker is open and the flange-mounted handle is in the **O (OFF)** position.

When the flange-mounted handle is in the **I (ON)** position, the door interlock prevents you from opening the door. To open the door, you must turn the handle to the **O (OFF)** position.

Under exceptional circumstances, qualified electrical personnel can override the interlock.

Follow the steps below to open the door with the circuit breaker in the **I (ON)** position:

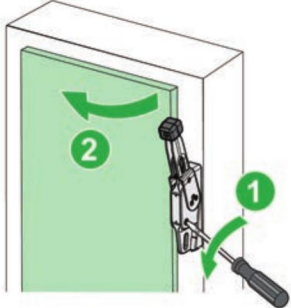
Step	Action	
1	With the handle in the I (ON) position, rotate the lock screw counter-clockwise.	
2	Hold the lock screw in that position while opening the door. NOTE: Follow the same procedure to close the door with the circuit breaker in the I (ON) position.	

Follow the steps below to close the circuit breaker (turn to **I (ON)** position) while the door is open:

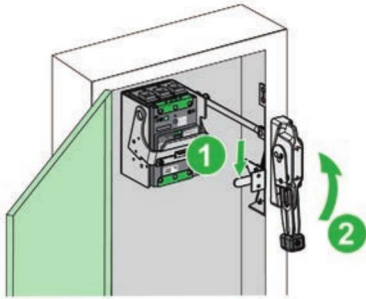
Step	Action	
1	Hold down the interlock bar	
2	Turn the handle to the I (ON) position.	

PowerPact B-Frame Electrical Auxiliary Devices

PowerPact B Electrical Auxiliary Devices

Summary of Electrical Auxiliary Devices

The following table shows electrical auxiliary devices that can be added to circuit breakers. Auxiliary contacts can be installed on site. For more information, see the PowerPact B-Frame Catalog .

Electrical Auxiliary Device	Use	1P	2P	3P/4P
OF auxiliary contact	View the on/off status of the circuit breaker remotely.	—	✓	✓
SD auxiliary contact	View the trip status of the circuit breaker remotely.	—	—	✓
MX shunt trip	Send an electrical trip command remotely.	—	✓	✓
MN undervoltage release	Trip the circuit breaker when the control voltage drops below a tripping threshold.	—	✓	✓
MN undervoltage release with time-delay unit.	Intended to avoid nuisance tripping in systems with frequent voltage dips lasting from 200 ms to 3 s.	—	✓	✓

Slots for Electrical Auxiliary Devices

The following figures show the available slots for electrical auxiliary devices mounted in the case. One auxiliary can be installed in each slot. For more information, see the PowerPact B-Frame Catalog.

2P Circuit Breaker

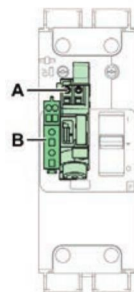

3P Circuit Breaker

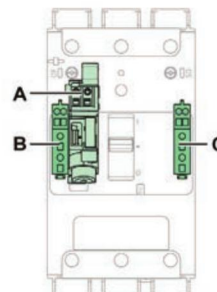

4P Circuit Breaker

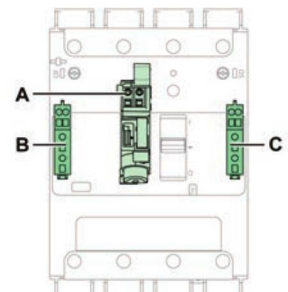

- A. MN undervoltage release or MX shunt trip
- B. OF auxiliary contact
- C. SD auxiliary contact

PowerPact B Indication Contacts

Characteristics of PowerPact B Indication Contacts

Use indication contacts to view the status of the circuit breaker remotely.

Indication contacts are located under the front face of the circuit breaker, in a compartment that is isolated from the power circuits. When an indication contact is present, a green flag is displayed on the front of the circuit breaker.

The contacts used for indication contacts are common point changeover contacts

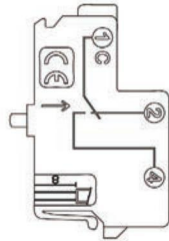

C(1) Common

NC(2) Normally closed contact. The NC contact is normally closed when the circuit breaker is in the O (OFF) position.

NO(4) Normally open contact. The NO contact is normally open when the circuit breaker is in the O (OFF) position.

NOTE:

The indication contact provides either OF or SD indication functions, depending on its location in the circuit breaker.

Name	Definition
OF open / close indication contact	The OF contact indicates the state of the circuit breaker, (I (ON) or O (OFF)/Trip). Changeover <ul style="list-style-type: none"> • O (OFF) to I (ON) • I (ON) to O (OFF) • I (ON) to Trip
SD trip indication contact	The SD contact indicates that the circuit breaker has tripped due to: <ul style="list-style-type: none"> • Operation of the push-to-trip button • Operation of the MX shunt trip or MN undervoltage release • Electrical fault detected by the protection Changeover <ul style="list-style-type: none"> • I (ON) to Trip • Trip to O (OFF)

Operation of PowerPact B Auxiliary Indication Contacts

The following figures show the position of the indication contacts for each position of the handle and main contacts.

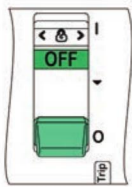
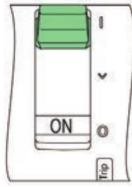
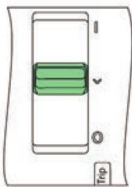
Name	Contact Number	Position of the handle and contacts		
		OFF	ON	Tripped (by MN/MX, push-to-trip, or protection)
Device status	—			Tripped (by MN/MX, push-to-trip, or protection)
Handle position	—			
Main contact position	—	Open	Closed	Open
OF auxiliary contact position	1-2	Closed	Open	Closed
	1-4	Open	Closed	Open
SD auxiliary contact position	1-2	Closed	Closed	Open
	1-4	Open	Open	Closed

PowerPact B Control Auxiliaries

PowerPact B-Frame Remote Electrical Trip

The following voltage release auxiliaries are operated remotely by an electrical trip command:

- MX shunt trip
- MN undervoltage release
- MN undervoltage release with time-delay unit. The time-delay unit helps to overcome nuisance tripping due to transient voltage dips. The time delay is adjustable up to three seconds.

NOTE: It is recommended to test the operation of a remote electrical trip at regular intervals, such as every six months.

Voltage release auxiliaries are installed in the case under the front face of the circuit breaker. The presence and characteristics of a voltage release auxiliary are displayed through a window on the front face.

The characteristics of voltage release auxiliaries comply with UL 489, CSA 22.2 No 5, and IEC/EN60947- 2 recommendations.

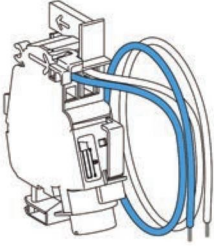
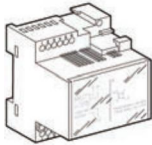
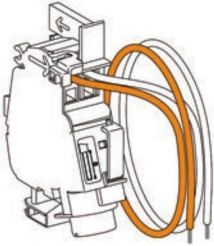
Name	Image	Description
MN undervoltage release		<ul style="list-style-type: none"> • Trips the circuit breaker when the voltage is less than 0.35 times the rated voltage (U_n). <ul style="list-style-type: none"> ◦ If the voltage is between 0.35 and 0.7 times the rated voltage (U_n), tripping can occur but is not certain to occur. ◦ If the voltage is above 0.7 times the rated voltage (U_n), tripping cannot occur. • Allows the circuit breaker to be closed again when the voltage reaches 0.85 times the rated voltage (U_n). <p>Use this type of accessory for failsafe emergency stops.</p>
Time-delay unit for MN undervoltage release Adjustable and fixed time-delay units are available.		<p>Removes nuisance tripping of an undervoltage release by setting a time delay of up to 3 s to overcome transient voltage dips.</p> <p>Adjustable and fixed time-delay units are available.</p>
MX shunt trip		<p>Trips the circuit breaker when the voltage exceeds 0.7 times the rated voltage (U_n).</p> <p>NOTE: MX shunt trip 110/130 Vac combined with Class I ground-fault sensing element is suitable for ground-fault protection. In this application, the circuit breaker trips when the voltage exceeds 0.55 times the rated voltage (U_n).</p>

Commissioning and Maintaining the PowerPact B-Frame Circuit Breaker

Commissioning the PowerPact B Circuit Breaker

List of Checks and Inspections

⚠️⚠️ DANGER

HAZARD OF ELECTRIC SHOCK, EXPLOSION, OR ARC FLASH

- Apply appropriate personal protective equipment (PPE) and follow safe electrical work practices. See NFPA 70E, CSA Z462, NOM-029-STPS, or local equivalent.
- This equipment must only be installed and serviced by qualified electrical personnel.
- Turn off all power supplying this equipment before working on or inside equipment.
- Turn off all power supplying the downstream equipment by manually opening the circuit breaker.
- Before working on or inside equipment, always use a properly rated voltage sensing device to confirm that power is off.
- Replace all devices, doors, and covers before turning on power to this equipment.
- Beware of potential hazards, and carefully inspect the work area for tools and objects that may have been left inside the equipment.

Failure to follow these instructions will result in death or serious injury.

When equipment is commissioned or returned to service after a lengthy downtime, perform a general check on the equipment.

The following table summarizes when to carry out checks or inspections:

When to Carry Out Checks and Inspections	A	B	C	D	E	F	G
Before commissioning new equipment	✓	✓	✓	✓	✓	✓	✓
Periodically during operation (see <i>Maintaining the PowerPact B Circuit Breaker during Operation</i> , page 74)	✓	—	—	—	✓	✓	✓
After carrying out work on the switchboard	—	—	✓	✓	✓	✓	✓
Periodically during lengthy downtime	—	—	✓	—	✓	—	✓
After a lengthy downtime	—	—	✓	—	✓	✓	✓
After a lengthy downtime and modification to the switchboard	✓	✓	✓	✓	✓	✓	✓

A Carry out insulation tests and dielectric strength tests

B Carry out temperature rise tests

C Inspect switchboard

D Check compliance with the diagram

E Inspect mechanical equipment

F Check mechanical operation

G Clean equipment

A: Insulation Tests and Dielectric Strength Tests

⚠ CAUTION

HAZARD OF INJURY OR EQUIPMENT DAMAGE

Insulation and dielectric strength tests must only be carried out by qualified electrical personnel.

Failure to follow these instructions can result in injury or equipment damage.

Insulation tests and dielectric strength tests are done before the switchboard is delivered. These tests are compliant with the currently applicable standards.

B: Temperature Rise Tests

Temperature rise tests are done before the switchboard is delivered. PowerPact B-frame circuit breakers comply with product standards IEC60947-1 and 2.

For general-purpose systems, tests are carried out at an ambient temperature of 40 °C (104 °F). Above 40 °C (104 °F), thermal protection characteristics are slightly modified and the values defined in the derating tables must be taken into account. These values are valid for circuit breakers with or without terminal shields.

C: Inspect Switchboard

Check that the circuit breakers are installed:

- In a clean environment, without waste from assembling the equipment (such as wiring, tools, shavings, metallic particles).
- In a properly ventilated switchboard (unobstructed ventilation grills).

D: Check Compliance with the Diagram

Check that the circuit breakers comply with the installation diagram:

- Identification of the feeds on the front of the circuit breakers
- Rating and breaking capacity (shown on the device identification label)
- Presence of additional functions (rotary handle, control, or indication auxiliaries, locking, sealing)

E: Inspect Mechanical Equipment

Visually inspect the general state of the circuit breakers: terminal shields and interphase barriers, protection, case, and connections.

Check the equipment integrity: a circuit breaker found with a cracked case or burn marks must be immediately taken out of service and replaced.

Check the mounting and mechanical strength of the following equipment:

- Circuit breakers in the switchboard, power connections, and heat sinks
- Auxiliaries and accessories on the circuit breakers:
 - Rotary handles
 - Installation accessories, such as terminal shields and interphase barriers
 - Auxiliary circuit connections
- Locks, padlocks, and padlock support tabs

F: Check Mechanical Operation

Check the mechanical operation of the circuit breaker:

- Opening
- Closing
- Tripping with the push-to-trip button
- Resetting

G: Clean Equipment

To reduce dust deposits that can affect the mechanical operation of circuit breakers, clean the circuit breakers when performing maintenance:

- Non-metallic parts: Always use a dry cloth. Do not use cleaning products.
- Metallic parts: Preferably use a dry cloth. If a cleaning product is used, do not apply or splash the cleaning product on non-metallic parts.

Maintaining the PowerPact B Circuit Breaker during Operation

 **DANGER**

HAZARD OF ELECTRIC SHOCK, EXPLOSION, OR ARC FLASH

- Apply appropriate personal protective equipment (PPE) and follow safe electrical work practices. See NFPA 70E, CSA Z462, NOM-029-STPS, or local equivalent.
- This equipment must only be installed and serviced by qualified electrical personnel.
- Turn off all power supplying this equipment before working on or inside equipment.
- Turn off all power supplying the downstream equipment by manually opening the circuit breaker.
- Before working on or inside equipment, always use a properly rated voltage sensing device to confirm that power is off.
- Replace all devices, doors, and covers before turning on power to this equipment.
- Beware of potential hazards, and carefully inspect the work area for tools and objects that may have been left inside the equipment.

Failure to follow these instructions will result in death or serious injury.

Like most equipment, electrical switchboards age whether they are being used or not. Aging is mostly caused by environmental influences and operating conditions.

To help circuit breakers keep the operating and safety characteristics specified in the catalog for the whole of their service life:

- Install circuit breakers in optimum environmental and operating conditions (described in the following table).
- Make sure that maintenance operations are carried out by qualified electrical personnel.

Environmental and Operating Conditions

The following table describes optimum environmental and operating conditions.

Environmental and Operating Factors	Optimum Conditions
Temperature	Average annual temperature outside the switchboard is < 25 °C (77 °F).
Loading	Loading is < 80% of In for 24 hours a day.
Harmonics	Harmonic current per phase is < 30% of In.
Humidity	Relative humidity is < 70%.
Corrosive atmosphere (SO ₂ , NH ₃ , H ₂ S, Cl ₂ , NO ₂)	The circuit breaker is installed in environmental category 3C1 or 3C2 (IEC60721-3-3).
Saline environment	The circuit breaker is installed in an environment free of salt mist.
Dust	The dust level is low. If necessary, the circuit breaker is in a switchboard that is fitted with filters or is IP54 ventilated.
Vibration	Continuous vibration is < 0.2 g.

Maintenance programs apply to optimum environmental and operating conditions. Outside these limits, circuit breakers are subject to accelerated aging, which can quickly lead to problems.

In harsh environmental and operating conditions, refer to the derating tables and reduce the maintenance intervals (see *Environmental Conditions*, page 18).



Regular Preventive Maintenance

Maintenance recommendations are intended to maintain the equipment or subassemblies in a satisfactory operational state for their useful service life.

The following table summarizes maintenance operations and intervals for the three preventive maintenance levels:

Maintenance Interval	Maintenance Operations	Performed by
1 year	Basic level tasks: visual inspection and functional testing, replacement of inoperative accessories.	<ul style="list-style-type: none"> • Qualified customer employee with basic training • Schneider Electric certified partner • Schneider Electric field services
2 years	Advanced level tasks: Basic level tasks, plus operational servicing and subassembly tests.	<ul style="list-style-type: none"> • Qualified technician with advanced training • Schneider Electric certified partner • Schneider Electric field services
3 years	Exclusive level tasks: Advanced level tasks, plus manufacturer diagnostics and part replacements by Schneider Electric Services.	<ul style="list-style-type: none"> • Schneider Electric field services

The maintenance intervals in the previous table are for normal environmental and operating conditions. If all environmental conditions are more favorable, maintenance intervals can be longer. For example,

Advanced level tasks could be carried out every three years.

If any one of the conditions is more severe, perform maintenance more frequently. For advice, contact Schneider Electric Services.

Functions linked specifically to safety require particular maintenance intervals.

NOTE: Regularly test that the remote safety commands work. For example, test at least every six months.

Maintenance Operations Required

Maintenance operations mainly consist of checks and inspections A, E, F, and G, as defined for commissioning (see *List of Checks and Inspections, page 71*).

⚠ CAUTION
HAZARD OF INJURY OR EQUIPMENT DAMAGE
Insulation and dielectric strength tests must only be carried out by qualified electrical personnel.
Failure to follow these instructions can result in injury or equipment damage.

Maintenance operation	Year 1	Year 2	Year 3	Year 4	Year 5
Insulation and dielectric strength tests (A)	✓	✓	✓	✓	✓
Inspect mechanical equipment (E)	✓	✓	✓	✓	✓
Measurement of insulation resistance	—	—	—	—	✓
Check mechanical operation (F)	✓	✓	✓	—	✓
Check the closing time, opening time, and voltage release characteristics	—	✓	—	✓	✓
Clean equipment (G)	✓	✓	✓	✓	✓

For a detailed definition of the maintenance operations, contact Schneider Electric Services.

Responding to a Powerpact B Circuit Breaker Trip

Taking Precautions Before Responding to a Trip

DANGER

HAZARD OF ELECTRIC SHOCK, EXPLOSION, OR ARC FLASH

- Apply appropriate personal protective equipment (PPE) and follow safe electrical work practices. See NFPA 70E, CSA Z462, NOM-029-STPS, or local equivalent.
- This equipment must only be installed and serviced by qualified electrical personnel.
- Turn off all power supplying this equipment before working on or inside equipment.
- Turn off all power supplying the downstream equipment by manually opening the circuit breaker.
- Before working on or inside equipment, always use a properly rated voltage sensing device to confirm that power is off.
- Replace all devices, doors, and covers before turning on power to this equipment.
- Beware of potential hazards, and carefully inspect the work area for tools and objects that may have been left inside the equipment.

Failure to follow these instructions will result in death or serious injury.

Before inspecting electrical equipment downstream of the protection, always isolate the feed.

Identifying the Cause of the Trip

A trip can be caused by the following events:

- Fault detection on the installation
- Fault detection caused by malfunction
- Intentional tripping

Check the circuit breaker and the electrical installation to find the root cause of the trip.

Checking Equipment After a Trip

⚠ CAUTION

HAZARD OF CLOSING ON ELECTRICAL FAULT

Do not close the circuit breaker without first inspecting and, if necessary, repairing the downstream electrical equipment.

Failure to follow these instructions can result in injury or equipment damage.

NOTE: Checks, tests, and inspections must be carried out by qualified electrical personnel.

The fact that the protection has tripped does not fix the cause of the fault detected on the downstream equipment.

Perform the following tasks after a short-circuit:

- Carefully clean off any traces of black smoke. The smoke particles can conduct electricity.
- Check the power connections and control wires.
- Operate the circuit breaker at least five times at zero load.

Depending on the type of fault detected, perform the following inspections on all or part of the equipment where the fault occurred (see *List of Checks and Inspections, page 71*):

- For faults tripped by thermal protection:
 - Check system for damage and repair if necessary.
 - Perform checks E and F.
- For faults tripped by magnetic protection or caused by an unknown reason:
 - Check the system for damage, and then repair if necessary.
 - Perform checks A, E, and F.

Resetting the Circuit Breaker

Before resetting the circuit breaker, make sure that the fault is identified and repaired, and that the installation has been checked.

If the system must be restarted quickly (for example, in a safety installation), isolate and lock out the affected part of the installation before carrying out maintenance.

The procedure for resetting a circuit breaker depends on the type of handle on the circuit breaker (see Table of Contents for resetting each type of handle).

Troubleshooting the PowerPact B Circuit Breaker

Repetitive Tripping

Indication	Probable Cause	Checks or Repairs
SD	The voltage of the power supply to the MN undervoltage release is too low or subject to significant variations.	Check the power supply for the release. For example, a supply powering motors with high-power ratings can be unstable. If necessary, connect the release to a clean or stable supply.
	The power supply to an MX shunt trip is applied unintentionally.	Compare the release connection with the installation diagram to make sure that it is correct.

Circuit Breaker Does Not Close

Indication	Probable Cause	Checks or Repairs
SD	MX shunt trip energized. MN undervoltage release not energized.	Compare the release connection with the installation diagram to make sure that it is correct.

Wiring Diagrams

PowerPact B Circuit Breaker Wiring Diagrams

PowerPact B DC Systems

Selection of a dc circuit breaker is based on the type of dc system, the rated voltage, and the maximum short-circuit current at the point of installation.

DC Systems

Distribution	Faults	Fault Comments	Worst Case
Ungrounded Source 	Fault B Fault A or C Faults A and D or Faults C and E	Isc maximum Both polarities (positive and negative) are involved in the fault. No consequences. Isc max Either polarity may be involved at voltage V.	Simultaneous faults at A and D or C and E Either polarity may be involved at voltage V ¹ .
Grounded Middle Point 	Fault B Fault A or C	Isc maximum Both polarities (positive and negative) are involved in the fault. Isc < Isc maximum at V/2 The negative or positive polarity is involved.	Fault B Each polarity may be involved at voltage V/2.
Grounded Negative 	Fault A Fault B	Isc maximum Positive polarity is involved in the fault. Isc maximum Both polarities (positive and negative) are involved in the fault.	Fault A All poles taking part in breaking must be placed in series on the positive polarity. If the negative polarity is grounded, an additional pole must be provided to be used for isolation of the negative pole but not for breaking.

1. NEC250.167 (A) requires that ungrounded DC systems must have a ground-fault detection system. In order to avoid a double fault condition on ungrounded DC systems, use a ground-fault detection system to detect the first fault and clear it with no delay.

PowerPact B DC Wiring Diagrams

Type	Grounded Negative ²	Grounded Middle Point	Ungrounded Source
	125 Vdc 250 Vdc	≤ 250 Vdc	≤ 250 Vdc
1P			
2P			
3P			
4P			

2. It is acceptable to ground the positive leg.

Grounded B-Phase Systems (Corner-Grounded Delta)

Three-Phase 240 Vac Corner-Grounded Delta System.

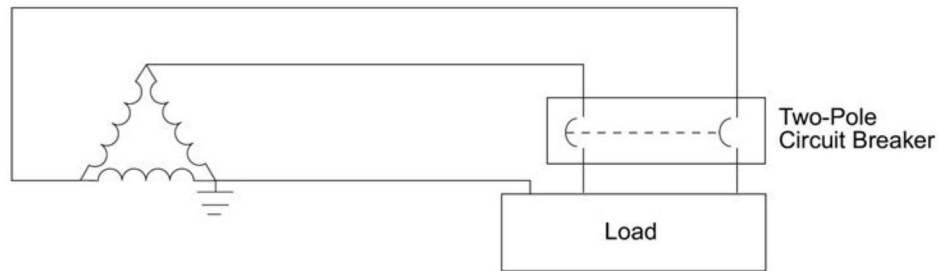

2P Frame

	BD	BG	BJ
Ampere Rating (A)	15–125		
Voltage Rating (Vac)	240		
UL Interrupting Rating (kA)	18	35	65

PowerPact B Electrical Accessory Wiring Diagrams

Indication Contacts

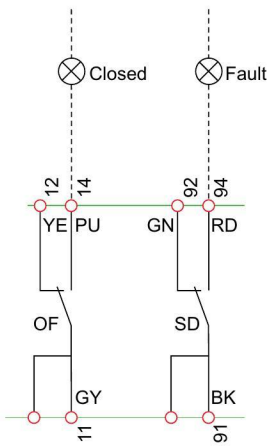

Indication Contacts

OF	Device ON/OFF indication contacts
SD	Trip indication contact

Color Code for Auxiliary Wiring

RD:	Red
YE:	Yellow
BK:	Black
GN:	Green
PU:	Purple
GY:	Grey

Remote Operation (MN/MX Voltage Release)

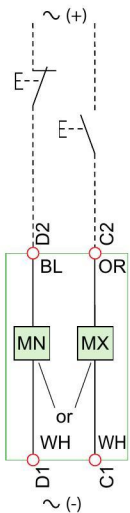

Remote Operation

MN	Undervoltage Release
or	
MX	Shunt trip Release

Color code for auxiliary wiring

OR:	Orange
BL:	Blue
WH:	White



RSPSupply - 1-888-532-2706 - <https://www.RSPSupply.com>
See the product details here

Schneider Electric USA, Inc.
800 Federal Street
Andover, MA 01810 USA
888-778-2733
www.schneider-electric.us

As standards, specifications, and design change from time to time,
please ask for confirmation of the information given in this publication.

© 2018 – Schneider Electric. All rights reserved.

DOCA0095EN



RSPSupply - 1-888-532-2706 - <https://www.RSPSupply.com>
See the product details here